

CM

Installation and operating instructions

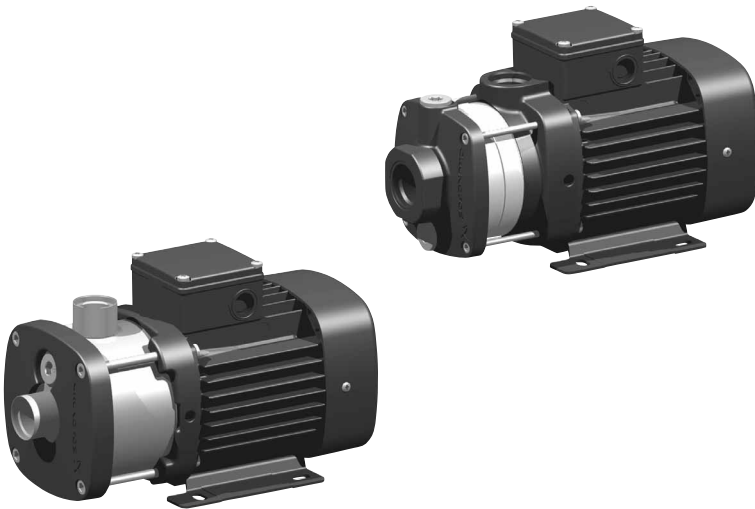

Declaration of conformity

GB: EC declaration of conformity

We, Grundfos, declare under our sole responsibility that the products CM, to which this declaration relates, are in conformity with these Council directives on the approximation of the laws of the EC member states:

- Machinery Directive (2006/42/EC).
Standards used: EN 809:1998 +A1:2009 and EN 60204-1:2006.
- Low Voltage Directive (2006/95/EC).
Applicable when the rated power is lower than 2.2 kW.
Standards used: EN 60335-1:2002 and EN 60335-2-51:2003.
- EMC Directive (2004/108/EC).
- Ecodesign Directive (2009/125/EC).
Electric motors:
Commission Regulation No 640/2009.
Applies only to three-phase Grundfos motors marked IE2 or IE3.
See motor nameplate.
Standard used: EN 60034-30:2009.
- Ecodesign Directive (2009/125/EC).
Water pumps:
Commission Regulation No 547/2012.
Applies only to water pumps marked with the minimum efficiency index MEI. See pump nameplate.

This EC declaration of conformity is only valid when published as part of the Grundfos installation and operating instructions (publication number 95121197 1212).

BG: ЕС декларация за съответствие

Ние, фирма Grundfos, заявяваме с пълна отговорност, че продуктите CM, за които се отнася настоящата декларация, отговарят на следните указания на Съвета за уеднавяване на правните разпоредби на държавите членки на ЕС:

- Директива за машините (2006/42/EC).
Приложени стандарти: EN 809:1998 +A1:2009 и EN 60204-1:2006.
- Директива за нисковолтови системи (2006/95/EC).
Приложим за помпи с номинална мощност по-малка от 2,2 kW.
Приложени стандарти: EN 60335-1:2002 и EN 60335-2-51:2003.
- Директива за електромагнитна съвместимост (2004/108/EC).
- Директива за екодизайн (2009/125/EC).
Електродвигатели:
Наредба No 640/2009 на Европейската комисия.
Отнася се само за трифазни електродвигатели на Grundfos, маркирани с IE2 или IE3. Вижте табелата с данни на двигателя.
Приложен стандарт: EN 60034-30:2009.
- Директива за екодизайн (2009/125/EC).
Водни помпи:
Наредба No 547/2012 на Европейската комисия.
Отнася се само за водни помпи, маркирани с минималният индекс за ефективност MEI. Вижте табелата с данни на помпата.

Тази ЕС декларация за съответствие е валидна само когато е публикувана като част от инструкциите за монтаж и експлоатация на Grundfos (номер на публикацията 95121197 1212).

CZ: ES prohlášení o shodě

My firma Grundfos prohlašujeme na svou plnou odpovědnost, že výrobky CM, na něž se toto prohlášení vztahuje, jsou v souladu s ustanoveními směrnice Rady pro sblížení právních předpisů členských států Evropského společenství v oblasti:

- Směrnice pro strojní zařízení (2006/42/ES).
Použité normy: EN 809:1998 +A1:2009 a EN 60204-1:2006.
- Směrnice pro nízkonapěťové aplikace (2006/95/ES).
Použitelná, pokud je jmenovitý výkon nižší než 2,2 kW.
Použité normy: EN 60335-1:2002 a EN 60335-2-51:2003.
- Směrnice pro elektromagnetickou kompatibilitu (EMC) (2004/108/ES).
- Směrnice o ekodesignu (2009/125/ES).
Elektrické motory:
Nařízení Komise č. 640/2009.
Platí pouze pro třífázové motory Grundfos označené IE2 nebo IE3. Viz typový štítek motoru.
Použitá norma: EN 60034-30:2009.
- Směrnice o ekodesignu (2009/125/ES).
Vodní čerpadla:
Nařízení Komise č. 547/2012.
Vztahuje se pouze na vodní čerpadla označená minimální účinností index MEI. Viz typový štítek čerpadla.

Toto ES prohlášení o shodě je platné pouze tehdy, pokud je zveřejněno jako součást instalačních a provozních návodů Grundfos (publikace číslo 95121197 1212).

DK: EF-overensstemmelseserklæring

Vi, Grundfos, erklærer under ansvar at produkterne CM som denne erklæring omhandler, er i overensstemmelse med disse af Rådets direktiver om indbyrdes tilnærmelse til EF-medlemsstaternes lovgivning:

- Maskindirektivet (2006/42/EF).
Anvendte standarder: EN 809:1998 +A1:2009 og EN 60204-1:2006.
- Lavspændingsdirektivet (2006/95/EF).
Gælder når mærkeeffekten er lavere end 2,2 kW.
Anvendte standarder: EN 60335-1:2002 og EN 60335-2-51:2003.
- EMC-direktivet (2004/108/EF).
- Ecodesigndirektivet (2009/125/EF).
Elektriske motorer:
Kommissionens forordning nr. 640/2009.
Gælder kun 3-fasede Grundfos-motorer der er mærket IE2 eller IE3. Se motorens typeskilt.
Anvendt standard: EN 60034-30:2009.
- Ecodesigndirektivet (2009/125/EF).
Vandpumper:
Kommissionens forordning nr. 547/2012.
Gælder kun vandpumper der er mærket med mindsteeffektivitetsindekset MEI. Se pumpens typeskilt.
Denne EF-overensstemmelseserklæring er kun gyldig når den publiceres som en del af Grundfos-monterings- og driftsinstruktionen (publikationsnummer 95121197 1212).

DE: EG-Konformitätserklärung

Wir, Grundfos, erklären in alleiniger Verantwortung, dass die Produkte CM, auf die sich diese Erklärung bezieht, mit den folgenden Richtlinien des Rates zur Angleichung der Rechtsvorschriften der EU-Mitgliedsstaaten übereinstimmen:

- Maschinenrichtlinie (2006/42/EG);
Normen, die verwendet wurden: EN 809:1998 +A1:2009 und EN 60204-1:2006.
- Niederspannungsrichtlinie (2006/95/EG).
Zutreffend für Nennleistungen kleiner 2,2 kW.
Normen, die verwendet wurden: EN 60335-1:2002 und EN 60335-2-51:2003.
- EMV-Richtlinie (2004/108/EG).
- ErP-Richtlinie (2009/125/EG).
Elektromotoren:
Verordnung der Europäischen Kommission Nr. 640/2009.
Gilt nur für dreiphasige Motoren von Grundfos mit der Kennzeichnung IE2 bzw. IE3. Siehe Typenschild des Motors.
Norm, die verwendet wurde: EN 60034-30:2009.
- ErP-Richtlinie (2009/125/EG).
Wasserpumpen:
Verordnung der Europäischen Kommission Nr. 547/2012.
Gilt nur für Pumpen, für die der Mindesteffizienzindex (MEI) anzuzeigen ist. Siehe Typenschild der Pumpe.

Diese EG-Konformitätserklärung gilt nur, wenn sie in Verbindung mit der Grundfos Montage- und Betriebsanleitung (Veröffentlichungsnummer 95121197 1212) veröffentlicht wird.

GR: Δήλωση συμμόρφωσης EC

Εμείς, η Grundfos, δηλώνουμε με αποκλειστικά δική μας ευθύνη ότι τα προϊόντα CM στα οποία αναφέρεται η παρούσα δήλωση, συμμορφώνονται με τις εξής Οδηγίες του Συμβουλίου περί προσέγγισης των νομοθεσιών των κρατών μελών της ΕΕ:

- Οδηγία για μηχανήματα (2006/42/ΕC).
Πρότυπα που χρησιμοποιήθηκαν: EN 809:1998 +A1:2009 και EN 60204-1:2006.
- Οδηγία χαμηλής τάσης (2006/95/ΕC).
Ισχύει όταν η ονομαστική ισχύς είναι κάτω από 2,2 kW.
Πρότυπα που χρησιμοποιήθηκαν: EN 60335-1:2002 και EN 60335-2-51:2003.
- Οδηγία Ηλεκτρομαγνητικής Συμβατότητας (EMC) (2004/108/ΕC).
- Οδηγία Οικολογικού Σχεδιασμού (2009/125/ΕC).
Ηλεκτρικοί κινητήρες;
Ρύθμιση πρώτης εκκίνησης Νο 640/2009.
Ισχύει μόνο σε τριφασικούς κινητήρες της Grundfos με σήμανση IE2 ή IE3. Βλέπε πινακίδα κινητήρα.
- Πρότυπο που χρησιμοποιήθηκε: EN 60034-30:2009.
- Οδηγία Οικολογικού Σχεδιασμού (2009/125/ΕC).
Αντλίες νερού:
Ρύθμιση πρώτης εκκίνησης Νο 547/2012.
Ισχύει μόνο για αντλίες νερού που φέρουν τον ελάχιστο δείκτη απόδοσης MEI. Βλέπε πινακίδα αντλίας.

Αυτή η δήλωση συμμόρφωσης EC ισχύει μόνον όταν συνοδεύει τις οδηγίες εγκατάστασης και λειτουργίας της Grundfos (κωδικός εντύπου 95121197 1212).

FR: Déclaration de conformité CE

Nous, Grundfos, déclarons sous notre seule responsabilité, que les produits CM, auxquels se réfère cette déclaration, sont conformes aux Directives du Conseil concernant le rapprochement des législations des Etats membres CE relatives aux normes énoncées ci-dessous:

- Directive Machines (2006/42/CE).
Normes utilisées: 809:1998 +A1:2009 et EN 60204-1:2006.
- Directive Basse Tension (2006/95/CE).
Applicable lorsque la puissance nominale est inférieure à 2,2 kW.
Normes utilisées: EN 60335-1:2002 et EN 60335-2-51:2003.
- Directive Compatibilité Electromagnétique CEM (2004/108/CE).
- Directive sur l'éco-conception (2009/125/CE).
Moteurs électriques:
Règlement de la Commission N° 640/2009.
S'applique uniquement aux moteurs triphasés Grundfos marqués IE2 ou IE3. Voir plaque signalétique du moteur.
Norme utilisée: EN 60034-30:2009.
- Directive sur l'éco-conception (2009/125/CE).
Pompes à eau:
Règlement de la Commission N° 547/2012.
S'applique uniquement aux pompes à eau marquées de l'indice de performance minimum IEM. Voir plaque signalétique de la pompe.

Cette déclaration de conformité CE est uniquement valide lors de sa publication dans la notice d'installation et de fonctionnement Grundfos (numéro de publication 95121197 1212).

EE: EL vastavusdeklaratsioon

Meie, Grundfos, deklareerime enda ainuvastutuse, et tooted CM, mille kohta käesolev juhend käib, on vastavuses EÜ Nõukogu direktiividega EMÜ liikmesriikide seaduste ühitamise kohta, mis käsitlevad:

- Masinate ohutus (2006/42/EC).
Kasutatud standardid: EN 809:1998 +A1:2009 ja EN 60204-1:2006.
- Madalpinge direktiiv (2006/95/EC).
Rakendatav kui võimsus on vähem kui 2,2 kW.
Kasutatud standardid: EN 60335-1:2002 ja EN 60335-2-51:2003.
- Elektromagnetilise ühilduvus (EMC direktiiv) (2004/108/EC).
- Ökodesaini direktiiv (2009/125/EC).
Elektrimootorid:
Komisjoni regulatsioon nr 640/2009.
Kehtib ainult IE2- või IE3-märgisega Grundfos kolmefaasiliste mootorite kohta. Vaata mootori sildid.
Kasutatud standard: EN 60034-30:2009.
- Ökodesaini direktiiv (2009/125/EC).
Veepumbad:
Komisjoni regulatsioon nr 547/2012.
Kehtib ainult veepumpadele, mis on märgitud miinimum kasutegurit indeksi MEI. Vaata pumba silti.

Käesolev EL-i vastavusdeklaratsioon kehtib ainult siis, kui see avaldatakse Grundfosi paigaldus- ja kasutusjuhendi (avaldamisnumber 95121197 1212) osana.

ES: Declaración CE de conformidad

Nosotros, Grundfos, declaramos bajo nuestra entera responsabilidad que los productos CM, a los cuales se refiere esta declaración, están conformes con las Directivas del Consejo en la aproximación de las leyes de los Estados Miembros del EM:

- Directiva de Maquinaria (2006/42/CE).
Normas aplicadas: EN 809:1998 +A1:2009 y EN 60204-1:2006.
- Directiva de Baja Tensión (2006/95/CE).
Aplicable cuando la potencia nominal es inferior a 2,2 kW.
Normas aplicadas: EN 60335-1:2002 y EN 60335-2-51:2003.
- Directiva EMC (2004/108/CE).
- Directiva sobre diseño ecológico (2009/125/CE).
Motores eléctricos:
Reglamento de la Comisión N° 640/2009.
Válido sólo para motores trifásicos Grundfos pertenecientes a las categorías IE2 e IE3. Véase la placa de características del motor.
Norma aplicada: EN 60034-30:2009.
- Directiva sobre diseño ecológico (2009/125/CE).
Bombas de agua:
Reglamento de la Comisión N° 547/2012.
Aplicable únicamente a las bombas de agua marcadas con el índice de eficiencia mínima (IEM). Véase la placa de características de la bomba.

Esta declaración CE de conformidad sólo es válida cuando se publique como parte de las instrucciones de instalación y funcionamiento de Grundfos (número de publicación 95121197 1212).

HR: EZ izjava o usklađenosti

Mi, Grundfos, izjavljujemo pod vlastitom odgovornošću da je proizvod CM, na koji se ova izjava odnosi, u skladu s direktivama ovog Vijeća o usklađivanju zakona država članica EU:

- Direktiva za strojeve (2006/42/EZ).
Korištena norma: EN 809:1998 +A1:2009 i EN 60204-1:2006.
- Direktiva za niski napon (2006/95/EZ).
Primjenjuje se kada je nazivna snaga niža od 2,2 kW.
Korištena norma: EN 60335-1:2002 i EN 60335-2-51:2003.
- Direktiva za elektromagnetsku kompatibilnost (2004/108/EZ).
- Direktiva o ekološkoj izvedbi (2009/125/EZ).
Električni motori:
Uredba Komisije No 640/2009.
Odnosi se samo na trofazne Grundfos motore s oznakama IE2 ili IE3. Pogledajte natpisnu pločicu motora.
Korištena norma: EN 60034-30:2009.
- Direktiva o ekološkoj izvedbi (2009/125/EZ).
Crpke za vodu:
Uredba Komisije No 547/2012.
Odnosi se samo na crpke za vodu označene s indeksom minimalne učinkovitosti MEI. Pogledajte natpisnu pločicu crpke.

Ova EZ izjava o usklađenosti važeća je jedino kada je izdana kao dio Grundfos montažnih i pogonskih uputa (broj izdanja 95121197 1212).

IT: Dichiarazione di conformità CE

Grundfos dichiara sotto la sua esclusiva responsabilità che i prodotti CM, ai quali si riferisce questa dichiarazione, sono conformi alle seguenti direttive del Consiglio riguardanti il riavvicinamento delle legislazioni degli Stati membri CE:

- Direttiva Macchine (2006/42/CE).
Norme applicate: EN 809:1998 +A1:2009 e EN 60204-1:2006.
 - Direttiva Bassa Tensione (2006/95/CE).
E' applicabile quando la potenza nominale è inferiore a 2,2 kW.
Norme applicate: EN 60335-1:2002 e EN 60335-2-51:2003.
 - Direttiva EMC (2004/108/CE).
 - Direttiva Ecodesign (2009/125/CE).
Motori elettrici:
Regolamento CE n. 640/2009.
Applicabile solo ai motori trifase Grundfos contrassegnati IE2 o IE3. Vedere la targhetta di identificazione del motore.
Norma applicata: EN 60034-30:2009.
 - Direttiva Ecodesign (2009/125/CE).
Pompe per acqua:
Regolamento CE n. 547/2012.
Applicabile solo a pompe per acqua con l'indice di efficienza minimo MEI. Vedere la targhetta di identificazione della pompa.
- Questa dichiarazione di conformità CE è valida solo quando pubblicata come parte delle istruzioni di installazione e funzionamento Grundfos (pubblicazione numero 95121197 1212).

LT: EB atitikties deklaracija

Mes, Grundfos, su visa atsakomybe pareiškiame, kad gaminiai CM, kuriems skirta ši deklaracija, atitinka šias Tarybos Direktyvas dėl Europos Ekonominės Bendrijos šalių įstatymų suderinimo:

- Mašinu direktyva (2006/42/EB).
Taikomi standartai: EN 809:1998 +A1:2009 ir EN 60204-1:2006.
 - Žemų įtampų direktyva (2006/95/EB).
Galiajo, kai nominali galia yra mažesnė kaip 2,2 kW.
 - Taikomi standartai: EN 60335-1:2002 ir EN 60335-2-51:2003.
 - EMS direktyva (2004/108/EB).
 - Ekologinio projektavimo direktyva (2009/125/EB).
Elektros varikliai:
Komisijos reglamentas Nr. 640/2009.
Taikoma tik trifaziams Grundfos varikliams, pažymėtiems IE2 arba IE3. Žr. variklio varinė plokštėle.
Taikomas standartas: EN 60034-30:2009.
 - Ekologinio projektavimo direktyva (2009/125/EB).
Vandens siurbiai:
Komisijos reglamentas Nr. 547/2012.
Galiajo tik vandens siurbliams, ant kurių nurodytas minimalus efektyvumo koeficientas MEI. Žr. siurblio varinė plokštėle.
- Ši EB atitikties deklaracija galioja tik tuo atveju, kai yra pateikta kaip "Grundfos" įrengimo ir naudojimo instrukcijos (leidimo numeris 95121197 1212) dalis.

NL: EC overeenkomstigheidsverklaring

Wij, Grundfos, verklaren geheel onder eigen verantwoordelijkheid dat de producten CM waarop deze verklaring betrekking heeft, in overeenstemming zijn met de Richtlijnen van de Raad in zake de onderlinge aanpassing van de wetgeving van de EG Lidstaten betreffende:

- Machine Richtlijn (2006/42/EC).
Gebruikte normen: EN 809:1998 +A1:2009 en EN 60204-1:2006.
 - Laagspannings Richtlijn (2006/95/EC).
Van toepassing bij nominaal vermogen lager dan 2,2 kW.
Gebruikte normen: EN 60335-1:2002 en EN 60335-2-51:2003.
 - EMC Richtlijn (2004/108/EC).
 - Ecodesign Richtlijn (2009/125/EC).
Elektromotoren:
Verordening (EG) Nr. 640/2009 van de Commissie.
Geldt alleen voor de driefase elektromotoren van Grundfos, aangeduid met IE2 of IE3. Zie het typeplaatje van de motor.
Gebruikte norm: EN 60034-30:2009.
 - Ecodesign Richtlijn (2009/125/EC).
Waterpompen:
Verordening (EG) Nr. 547/2012 van de Commissie.
Is alleen van toepassing op waterpompen die gekenmerkt worden door de minimale efficiëntie index MEI. Zie het typeplaatje van de pomp.
- Deze EC overeenkomstigheidsverklaring is alleen geldig wanneer deze gepubliceerd is als onderdeel van de Grundfos installatie- en bedieningsinstructies (publicatienummer 95121197 1212).

LV: EK paziņojums par atbilstību prasībām

Sabiedrība GRUNDFOS ar pilnu atbildību dara zināmu, ka produkti CM, uz kuriem attiecas šis paziņojums, atbilst šādām Padomes direktīvām par tuvināšanas EK dalībvalstu likumdošanas normām:

- Mašīnbūves direktīva (2006/42/EK).
Piemērotie standarti: EN 809:1998 +A1:2009 un EN 60204-1:2006.
 - Zema sprieguma direktīva (2006/95/EK).
Piemērojama, ja nominālā jauda ir mazāka par 2,2 kW.
Piemērotie standarti: EN 60335-1:2002 un EN 60335-2-51:2003.
 - Elektromagnētiskās sadarbības direktīva (2004/108/EK).
 - Ekodizaina direktīva (2009/125/EK).
Elektriskie motori:
Komisijas regula Nr. 640/2009.
Attiecas tikai uz trīsfāžu Grundfos motoriem, kas apzīmēti ar IE2 vai IE3. Sk. motora pases datu plāksnīti.
Piemērotais standarts: EN 60034-30:2009.
 - Ekodizaina direktīva (2009/125/EK).
Ūdens sūkņi:
Komisijas regula Nr. 547/2012.
Attiecas tikai uz ūdens sūkņiem, kuriem ir minimālais efektivitātes indekss MEI. Sk. sūkņa pases datu plāksnīti.
- Šī EK atbilstības deklarācija ir derīga vienīgi tad, ja ir publicēta kā daļa no GRUNDFOS uzstādīšanas un ekspluatācijas instrukcijām (publikācijas numurs 95121197 1212).

HU: EK megfeleléségi nyilatkozat

Mi, a Grundfos, egyedüli felelősséggel kijelentjük, hogy a CM termékek, amelyekre jelen nyilatkozik vonatkozik, megfelelnek az Európai Unió tagállamainak jogi irányelvéit összehangoló tanács alábbi előírásainak:

- Gépek (2006/42/EK).
Alkalmazott szabványok: EN 809:1998 +A1:2009 és EN 60204-1:2006.
 - Kifeszültségű Direktíva (2006/95/EK).
Akkor alkalmazható, amikor a névleges teljesítmény kisebb mint 2,2 kW.
Alkalmazott szabványok: EN 60335-1:2002 és EN 60335-2-51:2003.
 - EMC Direktíva (2004/108/EK).
 - Környezetbarát tervezésre vonatkozó irányelv (2009/125/EK).
Villamos motorok:
Az Európai Bizottság 640/2009. számú rendelete.
Csak az IE2 vagy IE3 jelzésű háromfázisú Grundfos motorokra vonatkozik. Lásd a motor adattábláját.
Alkalmazott szabvány: EN 60034-30:2009.
 - Környezetbarát tervezésre vonatkozó irányelv (2009/125/EK).
Víz szivattyúk:
Az Európai Bizottság 547/2012. számú rendelete.
Csak a MEI minimum hatásfok index-el jelölt víz szivattyúkra vonatkozik. Lásd a szivattyú adattábláját.
- Ez az EK megfeleléségi nyilatkozat kizárólag akkor érvényes, ha Grundfos telepítési és üzemeltetési utasítás (kiadvány szám 95121197 1212) részeként kerül kiadásra.

UA: Декларация відповідності ЄС

Компанія Grundfos заявляє про свою виключну відповідальність за те, що продукти CM, на які поширюється дана декларація, відповідають таким рекомендаціям Ради з уніфікації правових норм країн - членів ЄС:

- Механічні прилади (2006/42/ЄС).
Стандарти, що застосовувалися: EN 809:1998 +A1:2009 та EN 60204-1:2006.
 - Низька напруга (2006/95/ЄС).
Може застосовуватися при потужності до 2,2 кВт.
Стандарти, що застосовувалися: EN 60335-1:2002 та EN 60335-2-51:2003.
 - Електромагнітна сумісність (2004/108/ЄС).
 - Директива з екодизайну (2009/125/ЄС).
Електродвигуни:
Регламент Комісії № 640/2009.
Застосовуються тільки до трифазних електродвигунів Grundfos, позначених IE2 або IE3. Дивіться паспортну таблицю електродвигуна.
Стандарти, що застосовувалися: EN 60034-30:2009.
 - Директива з екодизайну (2009/125/ЄС).
Насоси для води:
Регламент Комісії № 547/2012.
Стосуються тільки насосів для води, що відзначені мінімальним показником ефективності MEI. Дивіться паспортну таблицю на насосі.
- Ця декларація відповідності ЄС дійсна тільки в тому випадку, якщо публікується як частина інструкції Grundfos з монтажу та експлуатації (номер публікації 95121197 1212).

ID: EC pernyataan kesesuaian

Dengan ini, Grundfos, sebagai penanggung jawab tunggal menyatakan bahwa produk CM telah sesuai dengan ketentuan-ketentuan Dewan yang merujuk pada hukum negara-negara anggota Komisi Eropa berikut ini:

- Ketentuan Mesin (2006/42/EC).
Standar yang digunakan: EN 809:1998 +A1:2009 dan EN 60204-1:2006.
- Ketentuan Mengenai Keamanan Peralatan Bertegangan Rendah (2006/95/EC).
Dapat digunakan saat aliran daya lebih rendah dari 2,2 kW.
Standar yang digunakan: EN 60335-1:2002 dan EN 60335-2-51:2003.
- Ketentuan Mengenai Kompabilitas Elektromagnetik (2004/108/EC).
- Ecodesign Directive (2009/125/EC).
Motor elektrik:
Regulasi Komisi No. 640/2009.
Berlaku hanya untuk motor tiga fasa Grundfos yang diberi tanda IE2 atau IE3. Lihat pelat label.
Standar yang digunakan: EN 60034-30:2009.
- Ecodesign Directive (2009/125/EC).
Pompa air:
Regulasi Komisi No. 547/2012.
Berlaku hanya untuk pompa air bertanda MEI atau indeks efisiensi minimum. Lihat pelat nama pompa.

Deklarasi kesesuaian dengan EC hanya berlaku jika diterbitkan sebagai bagian dari petunjuk pengoperasian dan pemasangan Grundfos (nomor publikasi 95121197 1212).

PT: Declaração de conformidade CE

A Grundfos declara sob sua única responsabilidade que os produtos CM, aos quais diz respeito esta declaração, estão em conformidade com as seguintes Directivas do Conselho sobre a aproximação das legislações dos Estados Membros da CE:

- Directiva Máquinas (2006/42/CE).
Normas utilizadas: EN 809:1998 +A1:2009 e EN 60204-1:2006.
 - Directiva Baixa Tensão (2006/95/CE).
Aplicável quando a gama de potência for inferior a 2,2 kW.
Normas utilizadas: EN 60335-1:2002 e EN 60335-2-51:2003.
 - Directiva EMC (compatibilidade electromagnética) (2004/108/CE).
 - Directiva de Concepção Ecológica (2009/125/CE).
Motores eléctricos:
Regulamento da Comissão No 640/2009.
Aplica-se apenas a motores trifásicos Grundfos assinalados como IE2 ou IE3. Ver a chapa de características do motor.
Norma utilizada: EN 60034-30:2009.
 - Directiva de Concepção Ecológica (2009/125/CE).
Bombas de água:
Regulamento da Comissão No 547/2012.
Aplica-se apenas a bombas de água registadas com o índice de eficiência mínimo MEI. Ver a chapa de características da bomba.
- Esta declaração de conformidade CE é apenas válida quando publicada como parte das instruções de instalação e funcionamento Grundfos (número de publicação 95121197 1212).

PL: Deklaracja zgodności WE

My, Grundfos, oświadczamy z pełną odpowiedzialnością, że nasze wyroby CM, których deklaracja niniejsza dotyczy, są zgodne z następującymi wytycznymi Rady d/s ujednolicenia przepisów prawnych krajów członkowskich WE:

- Dyrektywa Maszynowa (2006/42/WE).
Zastosowane normy: EN 809:1998 +A1:2009 oraz EN 60204-1:2006.
- Dyrektywa Niskonapięciowa (LVD) (2006/95/WE).
Ma zastosowanie tylko dla mocy silnika mniejszej od 2,2 kW.
Zastosowane normy: EN 60335-1:2002 oraz EN 60335-2-51:2003.
- Dyrektywa EMC (2004/108/WE).
- Dyrektywa Ekoprojektowa (2009/125/WE).
Silniki elektryczne:
Rozporządzenie komisji nr 640/2009.
Dotyczy tylko trójfazowych silników firmy Grundfos z oznaczeniami IE2 lub IE3. Patrz tabliczka znamionowa silnika.
Zastosowana norma: EN 60034-30:2009.
- Dyrektywa Ekoprojektowa (2009/125/WE).
Pompy do wody:
Rozporządzenie komisji nr 547/2012.
Dotyczy tylko pomp do tłoczenia wody z minimalnym indeksem sprawności silnika. Patrz tabliczka znamionowa pompy.

Deklaracja zgodności WE jest ważna tylko i wyłącznie wtedy kiedy jest opublikowana przez firmę Grundfos i umieszczona w instrukcji montażu i eksploatacji (numer publikacji 95121197 1212).

RU: Декларация о соответствии ЕС

Мы, компания Grundfos, со всей ответственностью заявляем, что изделия CM, к которым относится настоящая декларация, соответствуют следующим Директивам Совета Евросоюза об унификации законодательных предписаний стран-членов ЕС:

- Механические устройства (2006/42/ЕС).
Применяющиеся стандарты: EN 809:1998 +A1:2009 и EN 60204-1:2006.
 - Низковольтное оборудование (2006/95/ЕС).
Применяется, если номинальная мощность ниже 2,2 кВт.
Применяющиеся стандарты: EN 60335-1:2002 и EN 60335-2-51:2003.
 - Электромагнитная совместимость (2004/108/ЕС).
 - Директива по экологическому проектированию энергопотребляющей продукции (2009/125/ЕС).
Электродвигатели:
Регламент Комиссии ЕС № 640/2009.
Применяется только к трехфазным электродвигателям Grundfos, обозначенным IE2 или IE3. См. шильдик с техническими данными двигателя.
Применяющийся стандарт: EN 60034-30:2009.
 - Директива по экологическому проектированию энергопотребляющей продукции (2009/125/ЕС).
Насосы для перекачивания воды:
Регламент Комиссии ЕС № 547/2012.
Применяется только к насосам для перекачивания воды, промаркированным показателем минимальной эффективности MEI. См. фирменную табличку насоса.
- Данная декларация о соответствии ЕС имеет силу только в случае публикации в составе инструкции по монтажу и эксплуатации на продукцию производства компании Grundfos (номер публикации 95121197 1212).

RO: Declarație de conformitate CE

Noi, Grundfos, declarăm pe propria răspundere că produsele CM, la care se referă această declarație, sunt în conformitate cu aceste Directive de Consiliu asupra armonizării legilor Statelor Membre CE:

- Directiva Utilaj (2006/42/CE). Standarde utilizate: EN 809:1998 +A1:2009 și EN 60204-1:2006.
- Directiva Tensiune Joasă (2006/95/CE). Aplicabilă când consumul estimat este de până la 2,2 kW. Standarde utilizate: EN 60335-1:2002 și EN 60335-2-51:2003.
- Directiva EMC (2004/108/CE).
- Directiva Ecodesign (2009/125/CE). Motoare electrice: Regulamentul Comisiei nr. 640/2009. Se aplică numai motoarelor trifazate Grundfos cu marca IE2 sau IE3. Vezi plăcuța de identificare a motorului. Standard utilizat: EN 60034-30:2009.
- Directiva Ecodesign (2009/125/CE). Pompe de apă: Regulamentul Comisiei nr. 547/2012. Se aplică numai pompelor de apă cu marca de eficiență minimă index MEI. Vezi plăcuța de identificare a pompei.

Această declarație de conformitate CE este valabilă numai când este publicată ca parte a instrucțiunilor Grundfos de instalare și funcționare (număr publicație 95121197 1212).

SI: ES izjava o skladnosti

V Grundfosu s polno odgovornostjo izjavljamo, da so naši izdelki CM, na katere se ta izjava nanaša, v skladu z naslednjimi direktivami Sveta o približevanju zakonodaje za izenačevanje pravnih predpisov držav članic ES:

- Direktiva o strojih (2006/42/ES). Uporabljeni normi: EN 809:1998 +A1:2009 in EN 60204-1:2006.
- Direktiva o nizki napetosti (2006/95/ES). Aplikirano, kadar je nominalna moč nižja od 2,2 kW. Uporabljeni normi: EN 60335-1:2002 in EN 60335-2-51:2003.
- Direktiva o elektromagnetni združljivosti (EMC) (2004/108/ES).
- Eco-design direktiva (2009/125/ES). Električni motorji: Uredba Komisije št. 640/2009. Se nanaša samo na trofazne motorje Grundfos z oznako IE2 ali IE3. Glejte tipsko ploščico motorja. Uporabljena norma: EN 60034-30:2009.
- Eco-design direktiva (2009/125/ES). Vodne črpalke: Uredba Komisije št. 547/2012. Veja le za vodne črpalke označene z indeksom minimalne učinkovitosti MEI. Glejte tipsko ploščico črpalke.

ES izjava o skladnosti velja samo kadar je izdana kot del Grundfos instalacije in navodil delovanja (publikacija številka 95121197 1212).

FI: EY-vaatimustenmukaisuusvakuutus

Me, Grundfos, vakuutamme omalla vastuullamme, että tuotetut CM, joita tämä vakuutus koskee, ovat EY:n jäsenvaltioiden lainsäädännön yhdenmukaistamiseen tähtäävien Euroopan neuvoston direktiivien vaatimusten mukaisia seuraavasti:

- Konedirektiivi (2006/42/EG). Sovellettavat standardit: EN 809:1998 +A1:2009 ja EN 60204-1:2006.
- Pienjännitedirektiivi (2006/95/EG). Voimassa vain alle 2,2 kW nimellistehoille. Sovellettavat standardit: EN 60335-1:2002 ja EN 60335-2-51:2003.
- EMC-direktiivi (2004/108/EG).
- Ekologista suunnittelua koskeva direktiivi (2009/125/EG). Sähkömoottorit: Komission asetus nro 640/2009. Koskee vain Grundfosin IE2- tai IE3-merkityjä 3-vaiheemoottoreita. Katso moottorin arvokilvestä. Sovellettu standardi: EN 60034-30:2009.
- Ekologista suunnittelua koskeva direktiivi (2009/125/EG). Vesipumput: Komission asetus nro 547/2012. Koskee vain vesipumppuja, jotka on merkitty minimihyötysuhdeindeksillä MEI. Katso pumpan tyypikilvestä.

Tämä EY-vaatimustenmukaisuusvakuutus on voimassa vain, kun se julkaistaan osana Grundfosin asennus- ja käyttöohjeita (julkaisun numero 95121197 1212).

SK: Prehlásenie o konformite ES

My firma Grundfos prehlasujeme na svoju plnú zodpovednosť, že výrobky CM, na ktoré sa toto prehlásenie vzťahuje, sú v súlade s ustanovením smernice Rady pre zblíženie právnych predpisov členských štátov Európskeho spoločenstva v oblastiach:

- Smernica pre strojárove zariadenie (2006/42/ES).
- Použitie normy: EN 809:1998 +A1:2009 a EN 60204-1:2006.
- Smernica pre nízkonapäťové aplikácie (2006/95/ES). Môže sa používať v prípade, ak menovitý výkon je nižší než 2,2 kW.
- Použitie normy: EN 60335-1:2002 a EN 60335-2-51:2003.
- Smernica pre elektromagnetickú kompatibilitu (2004/108/ES).
- Smernica o ekodizajne (2009/125/ES). Elektromotory: Nariadenie Komisie č. 640/2009. Platné iba pre trojfázové motory Grundfos, označené ako IE2 alebo IE3. Viď typový štítok motora. Použitá norma: EN 60034-30:2009.
- Smernica o ekodizajne (2009/125/ES). Čerpadlá na vodu: Nariadenie Komisie č. 547/2012.

Vzťahuje sa iba na čerpadlá pre vodu označené minimálnym indexom energetickej účinnosti MEI. Viď typový štítok čerpadla. Toto prehlásenie o konformite ES je platné iba vtedy, ak je zverejnené ako súčasť montážnych a prevádzkových pokynov Grundfos (publikácia číslo 95121197 1212).

RS: EC deklaracija o konformitetu

Mi, Grundfos, izjavljamo pod vlastitom odgovornostjo da je proizvod CM, na koji se ova izjava odnosi, u skladu sa direktivama Saveta za usklađivanje zakona država članica EU:

- Direktiva za mašine (2006/42/EC). Korišćeni standardi: EN 809:1998 +A1:2009 i EN 60204-1:2006.
 - Direktiva niskog napona (2006/95/EC). Primenljivo kada je nominalna snaga manja od 2,2 kW. Korišćeni standardi: EN 60335-1:2002 i EN 60335-2-51:2003.
 - EMC direktiva (2004/108/EC).
 - Direktiva o ekološkom projektovanju (2009/125/EC). Električni motor: Uredba komisije br. 640/2009. Važi samo za trofazne Grundfos motore označene sa IE2 ili IE3. Pogledajte natpisnu pločicu motora. Korišćen standard: EN 60034-30:2009.
 - Direktiva o ekološkom projektovanju (2009/125/EC). Pumpe za vodu: Uredba Komisije br. 547/2012. Odnosi se samo na pumpe za vodu označene sa indeksom minimalne efikasnosti MEI. Pogledajte natpisnu pločicu pumpe.
- Ova EC deklaracija o konformitetu važeća je jedino kada je izdata kao deo Grundfos uputstava za instalaciju i rad (broj izdanja 95121197 1212).

SE: EG-försäkran om överensstämmelse

Vi, Grundfos, försäkrar under ansvar att produkterna CM, som omfattas av denna försäkran, är i överensstämmelse med rådets direktiv om inbördes närmande till EU-medlemsstaternas lagsiftning, avseende:

- Maskindirektivet (2006/42/EG). Tillämpade standarder: EN 809:1998 +A1:2009 och EN 60204-1:2006.
- Lågspänningsdirektivet (2006/95/EG). Gäller för nominell effekt under 2,2 kW. Tillämpade standarder: EN 60335-1:2002 och EN 60335-2-51:2003.
- EMC-direktivet (2004/108/EG).
- Ekodesigndirektivet (2009/125/EG). Elektriska motorer: Kommissionens förordning nr. 640/2009. Gäller endast trefas Grundfos-motorer märkta med IE2 eller IE3. Se motors typskylt. Tillämpad standard: EN 60034-30:2009.
- Ekodesigndirektivet (2009/125/EG). Vattenpumpar: Kommissionens förordning nr. 547/2012. Avser endast vattenpumpar markerade med min. effektivitetsindex (MEI). Se pumpens typskylt.

Denna EG-försäkran om överensstämmelse är endast giltig när den publiceras som en del av Grundfos monterings- och driftsinstruktion (publikation nummer 95121197 1212).

TR: EC uygunluk bildirgesi

Grundfos olarak bu beyannameye konu olan CM ürünlerinin, AB Üyesi Ülkelerin kanunlarını birbirine yaklaştırma üzerine Konsey Direktifleriyle uyumlu olduğunun yalnızca bizim sorumluluğumuz altında olduğunu beyan ederiz:

- Makineler Yönetmeliği (2006/42/EC).
Kullanılan standartlar: EN 809:1998 +A1:2009 ve EN 60204-1:2006.
- Düşük Voltaj Yönetmeliği (2006/95/EC).
Hesaplanmış güç 2,2 kW'tan düşükse uygulanabilir.
Kullanılan standartlar: EN 60335-1:2002 ve EN 60335-2-51:2003.
- EMC Direktifi (2004/108/EC).
- Çevreye duyarlı tasarım (Ecodesign) Direktifi (2009/125/EC).
Elektrikli motorlar:
640/2009 sayılı Komisyon Yönetmeliği.
Sadece IE2 veya IE3 işaretli trifaze Grundfos motorlar için geçerlidir. Motor bilgi etiketine bakınız.
Kullanılan standart: EN 60034-30:2009.
- Çevreye duyarlı tasarım (Ecodesign) Direktifi (2009/125/EC).
Devirdaim su pompaları:
547/2012 sayılı Komisyon Yönetmeliği.
Yalnızca Minimum Enerji Verimlilik Endeksine (MEI) dahil olan olan devirdaim su pompaları için geçerlidir. Pompanın bilgi etiketine bakın.

İşbu EC uygunluk bildirgesi, yalnızca Grundfos kurulum ve çalışma talimatlarının (basım numarası 95121197 1212) bir parçası olarak basıldığı takdirde geçerlilik kazanmaktadır.

CN: EC 产品合格声明书

我们格兰富在我们的全权责任下声明，产品 CM，即该合格证所指之产品，符合欧共体使其成员国法律趋于一致的以下欧共理事会指令：

- 机械设备指令 (2006/42/EC).
所用标准：EN 809:1998 +A1:2009 和 EN 60204-1:2006.
- 低电压指令 (2006/95/EC).
适用于额定功率小于 2,2 kW.
所用标准：EN 60335-1:2002 和 EN 60335-2-51:2003.
- 电磁兼容性指令 (2004/108/EC).
- 生态化设计指令 (2009/125/EC).
电动机：
欧委会规定第 640/2009 号。
只适用于带有 IE2 或 IE3 标志的格兰富三相电机。参见电机铭牌。
所用标准：EN 60034-30:2009.
- 生态化设计指令 (2009/125/EC).
水泵：
欧委会规定第 547/2012 号。
仅适用于标有最低效率指标 (MEI) 的水泵。见泵铭牌。
本 EC 合格性声明仅在作为格兰富安装与操作指导手册 (95121197 1212) 的一部分时有效。

JP: EC 適合宣言

Grundfos は、その責任の下に、CM 製品が EC 加盟諸国の法規に関連する、以下の評議会指令に適合していることを宣言します：

- 機械指令 (2006/42/EC).
適用規格：EN 809:1998 +A1:2009 および EN 60204-1:2006.
- 低電圧指令 (2006/95/EC).
定格出力 2.2 kW 以下に適用されます。
- 適用規格：EN 60335-1:2002 および EN 60335-2-51:2003.
- EMC 指令 (2004/108/EC).
- エコデザイン指令 (2009/125/EC).
- 電気モーター
委員会規定 No 640/2009.
IE2 または IE3 の表示がある三相 Grundfos モーターにのみ該当します。モーターのネームプレートをご確認ください。
- 適用規格：EN 60034-30:2009.
- エコデザイン指令 (2009/125/EC).
- 水用ポンプ：
委員会規定 No 547/2012.
最小効率指数 MEI を表示した水用ポンプのみに適用。ポンプ銘板を参照ください。

この EC 適合宣言は、グランドフォス取扱説明書 (出版番号 95121197 1212) の一部に掲載される場合のみ有効です。

KO: EC

Grundfos		CM
EC		
:		
—	(2006/42/EC). EN 809:1998 +A1:2009 EN 60204-1:2006.	
—	(2006/95/EC).	
2.2 kW		
— EMC	(2004/108/EC). (2009/125/EC).	
—	640/2009.	
IE2 IE3	3 Grundfos	
—	: EN 60034-30:2009. (2009/125/EC).	
MEI	547/2012.	
EC		가
(95121197 1212).	

Tatabánya, 15th November 2012



Jannek Uldal Christensen
Research and Development Manager
GRUNDFOS Manufacturing Ltd.
Búzavirág u. 14, Ipari Park
2800 Tatabánya, Hungary

Person authorised to compile technical file and empowered to sign the EC declaration of conformity.



Декларация о соответствии на территории РФ

Насосы типа СМ сертифицированы на соответствие требованиям
Технического регламента о безопасности машин и оборудования
(Постановление правительства РФ от 15.09.2009 № 753).

Сертификат соответствия:

№ С-ДК.АЯ56.В.03740, срок действия до 27.05.2017 г.

Истра, 15 ноября 2012 г.

Касаткина В. В.
Руководитель отдела качества,
экологии и охраны труда
ООО Грундфос Истра, Россия
143581, Московская область,
Истринский район,
дер. Лешково, д.188

Original installation and operating instructions.

CONTENTS

	Page
1. Symbols used in this document	9
2. Introduction	9
3. Delivery and handling	9
4. Applications	9
5. Identification	10
5.1 Nameplates	10
6. Mechanical installation	10
6.1 Installation of pump	10
6.2 Pipework	11
6.3 Alternative connection positions	11
6.4 Terminal box positions	11
7. Electrical installation	12
7.1 Supply cable	12
7.2 Motor protection	12
7.3 Electrical connection	12
7.4 Frequency converter operation	12
8. Start-up	13
8.1 Liquid filling	13
8.2 Checking the direction of rotation	13
9. Maintenance	14
9.1 Frost protection	14
9.2 Cleaning	14
10. Service	14
11. Technical data	14
11.1 Enclosure class	14
11.2 Sound pressure level	14
11.3 Ambient temperature	14
11.4 Maximum system pressure and permissible liquid temperature	15
11.5 Minimum inlet pressure	15
11.6 Maximum inlet pressure	15
12. Fault finding	16
13. Further product information	17
13.1 Service documentation	17
14. Disposal	17

 **Warning**
Prior to installation, read these installation and operating instructions. Installation and operation must comply with local regulations and accepted codes of good practice.

Warning

The use of this product requires experience with and knowledge of the product.

Persons with reduced physical, sensory or mental capabilities must not use this product, unless they are under supervision or have been instructed in the use of the product by a person responsible for their safety. Children must not use or play with this product.



1. Symbols used in this document

Warning

If these safety instructions are not observed, it may result in personal injury.



Warning

The surface of the product may be so hot that it may cause burns or personal injury.



Caution *If these safety instructions are not observed, it may result in malfunction or damage to the equipment.*

Note *Notes or instructions that make the job easier and ensure safe operation.*

2. Introduction

This manual describes the installation and operation of Grundfos CM pumps.

3. Delivery and handling

Grundfos CM pumps are delivered from factory in a packaging specially designed for manual transport or transport by fork-lift truck or a similar vehicle.

Note *In order to ensure safe transport, Grundfos recommends to transport the pumps with suitable lifting tools.*

4. Applications

CM pumps are horizontal, multistage centrifugal pumps for the pumping of clean, thin and non-explosive liquids, not containing solid particles or fibres that may attack the pump mechanically or chemically.



Warning

The pump must not be used for the transfer of flammable or toxic liquids.

5. Identification

5.1 Nameplates

The pump and motor nameplates are positioned on the motor fan cover or terminal box.

The data and information on the pump nameplate are described in the table below. See the nameplate in fig. 9 on page 305.

Pos.	Description
1	Pump type
2	Pump model
3	Maximum ambient temperature [°C] / [°F]
4	Temperature class
5	Minimum efficiency index
6	Maximum system pressure [bar] / [psi] / [MPa]
7	Maximum liquid temperature [°C] / [°F]
8	Hydraulic pump efficiency at best efficiency point
9	Insulation class
10	Motor protection
11	Rated flow [m ³ /h] / [GPM]
12	Head at rated flow [m] / [psi]
13	Maximum head [m] / [psi]

The data and information on the motor nameplate are described in the table below. See the nameplate in fig. 10 on page 305.

Pos.	Description
1	Motor designation
2	Number of poles
3	Number of phases and voltage [V]
4	Rated current [A]
5	Power output [kW]
6	Power output [HP]
7	Three-phase pumps only Motor efficiency [%]
8	Single-phase pumps only Capacitor size [µF] and voltage [V]
9	CE mark
10	TR mark
11	IE2 mark
12	Company name and address
13	Country of manufacture

6. Mechanical installation

Before installing the pump, check that the pump type and parts are as ordered.



Warning

When pumping hot or cold liquids, make sure that persons cannot accidentally come into contact with hot or cold surfaces.

6.1 Installation of pump

The pump must be installed on a plane surface and fixed so that it cannot be displaced during start-up and operation.

The pump must be installed so that air locks are avoided in the pump housing and pipework. Figure 1 shows the permissible pump positions.

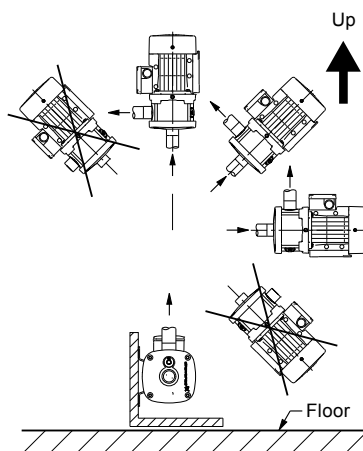

Fig. 1 Pump positions

The pump should be installed with easy access for inspection, maintenance and service.

The pump should be installed in a well-ventilated location.

6.2 Pipework

It is advisable to fit isolating valves on either side of the pump. It is thus not necessary to drain the system if the pump needs service. If the pump is installed above the liquid level, a non-return valve must be fitted in the suction pipe below the liquid level.

The pump must not be stressed by the pipework.

The pipework must be correctly sized taking due account of the pump inlet pressure.

If the pump is installed at the lowest point of the system, impurities and sludge may accumulate in the pump.

Install the pipes so that air locks are avoided, especially on the suction side of the pump. See fig. 2.

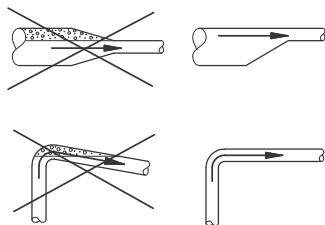

Fig. 2 Pipework

TM04 0338 0608

6.2.1 Pipe connection

Take care to avoid damaging the pump when connecting the suction and discharge pipes.

Caution

The torques in the table below must not be exceeded.

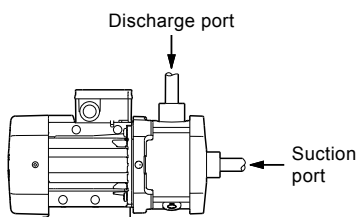

Fig. 3 Suction and discharge ports

TM04 0358 1008

Torques

Suction and discharge ports	Torque [Nm]
1"	50-60
1 1/4"	50-60
1 1/2"	50-60
2"	50-60

6.3 Alternative connection positions

The pump is available with various connection positions on special request. See fig. 4.

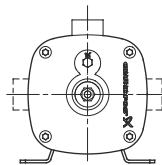

Fig. 4 Alternative connection positions

TM03 8709 1008

6.4 Terminal box positions

The pump is available with various terminal box positions on special request. See fig. 5.

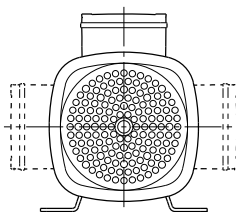

Fig. 5 Terminal box positions

TM04 0357 1008

7. Electrical installation

Warning

The electrical connection must be carried out in accordance with local regulations.



Before starting work on the pump, make sure that the power supply has been switched off and that it cannot be accidentally switched on.

The pump must be connected to an external mains switch with a contact gap of at least 3 mm in all poles.

Check that the mains voltage and frequency correspond to the values on the motor nameplate.

7.1 Supply cable

In order to comply with the EN 60335-1 standard, the supply cable must as minimum be rated for an operating temperature of +105 °C (+221 °F).

7.2 Motor protection

Single-phase motors, 1 x 115/230 V, 60 Hz, do not incorporate motor protection and must be connected to a motor-protective circuit breaker which can be manually reset. Set the motor-protective circuit breaker according to the rated current of the motor ($I_{1/1}$). See nameplate.

Other single-phase motors have built-in current- and temperature-dependent motor protection in accordance with IEC 60034-11 and require no further motor protection. The motor protection is of the TP 211 type, which reacts to both slow- and quick-rising temperatures. The motor protection is automatically reset.

Three-phase motors up to 3 kW must be connected to a motor-protective circuit breaker which can be manually reset. Set the motor-protective circuit breaker according to the rated current of the motor ($I_{1/1}$). See nameplate.

Motors with power ratings of 3 kW and up have built-in thermistors (PTC)*. The thermistors are designed according to DIN 44082. The motor protection is of the TP 211 type, which reacts to both slow- and quick-rising temperatures.

* Applies only to motors with the following supply voltages:

- 3 x 200 V/346 V, 50 Hz
- 3 x 200-220 V/346-380 V, 60 Hz.
- 3 x 220-240 V/380-415 V, 50 Hz.

Motors for other supply voltages must be connected to a motor-protective circuit breaker as described for three-phase motors up to 3 kW.

7.3 Electrical connection

Carry out the electrical connection as shown in the diagram inside the terminal box cover.

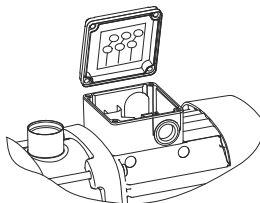

Fig. 6 Wiring diagram

7.4 Frequency converter operation

All three-phase motors can be connected to a frequency converter.

Depending on the frequency converter type, this may cause increased acoustic noise from the motor. Furthermore, it may cause the motor to be exposed to detrimental voltage peaks.

MG 71- and MG 80-based motors have no phase insulation* and must therefore be protected against voltage peaks higher than 650 V (peak value) between the supply terminals.

Caution

* MG 71- and MG 80-based motors with phase insulation are available on request.

The above disturbances, i.e. both increased acoustic noise and detrimental voltage peaks, can be eliminated by fitting an LC filter between the frequency converter and the motor.

For further information, please contact the frequency converter supplier or Grundfos.

8. Start-up

Caution *Do not start the pump until it has been filled with liquid.*

8.1 Liquid filling



Warning

Pay attention to the direction of the vent hole, and make sure that the escaping hot or cold liquid does not cause injury to persons or damage to the equipment.

1. Close the isolating valve on the discharge side of the pump.
2. Open the isolating valve in the suction pipe completely before starting the pump.
3. Remove the filling plug. See fig. 7.
4. Fill the pump housing and the suction pipe completely with liquid until a steady stream of liquid runs out of the filling hole.
5. Fit and tighten the filling plug.
6. Slowly open the discharge isolating valve while the pump is running. This ensures venting and pressure build-up during start-up.

Caution *The discharge valve must be opened immediately after start-up of the pump. Otherwise the temperature of the pumped liquid may become too high and cause material damage.*

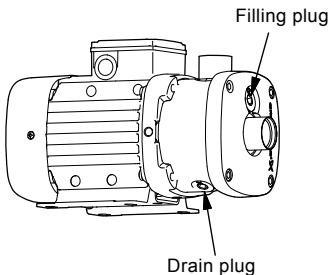

Fig. 7 Plugs in the pump sleeve

Note *If it is difficult for the pump to build up pressure, it may be necessary to repeat steps 1 to 6.*

8.2 Checking the direction of rotation

Note *The description below applies to three-phase motors only.*

The motor fan cover has an installation indicator. See fig. 8. Based on the motor cooling air, it indicates the direction of rotation of the motor. Before the motor is started for the first time or if the position of the indicator has been changed, the indicator function should be checked, for instance by moving the indicator field with a finger.

To determine whether the direction of rotation is correct or wrong, compare the indication with the table below.

Indicator field	Direction of rotation
Black	Correct
White/reflecting	Wrong*

* To reverse the direction of rotation, switch off the power supply and interchange any two of the incoming supply wires.

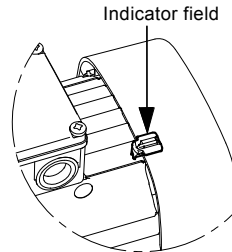

Fig. 8 Installation indicator

The indicator can be placed in various positions on the motor, but it must not be placed between the cooling fins close to the screws holding the fan cover. The correct direction of rotation is also shown by arrows on the motor fan cover.

TM03 8774 1008

TM04 0360 1008

9. Maintenance



Warning

Before starting work on the pump, make sure that the power supply has been switched off and that it cannot be accidentally switched on.



Warning

Make sure that the escaping water does not cause injury to persons or damage to the equipment.

The internal pump parts are maintenance-free. It is important to keep the motor clean in order to ensure adequate cooling of the motor. If the pump is installed in dusty environments, it must be cleaned and checked regularly. Take the enclosure class of the motor into account when cleaning.

The motor has maintenance-free, greased-for-life bearings.

9.1 Frost protection

Pumps which are not being used during periods of frost should be drained to avoid damage.

Remove the filling and drain plugs. See fig. 7.

Do not refit the plugs until the pump is taken into operation again.

Caution

Before start-up after a period of inactivity, the pump and the suction pipe should be completely filled with liquid. See section 8.1 Liquid filling.

9.2 Cleaning

Prior to a long period of inactivity, the pump must be flushed with clean water to prevent corrosion and deposits in the pump.

10. Service

Caution

If a pump has been used for a liquid which is injurious to health or toxic, the pump will be classified as contaminated.

Before returning the pump to Grundfos for service, the **safety declaration** at the end of these instructions must be filled in by authorised personnel and attached to the pump in a visible position.

If Grundfos is requested to service the pump, it must be ensured that the pump is free from substances that can be injurious to health or toxic. If the pump has been used for such substances, the pump must be cleaned before it is returned.

If proper cleaning is not possible, all relevant information about the chemical must be provided.

If the above is not fulfilled, Grundfos can refuse to accept the pump for service.

Possible costs of returning the pump are paid by the customer.

The safety declaration can be found at the end of these instructions (only in English).

11. Technical data

11.1 Enclosure class

- Standard: IP55.

11.2 Sound pressure level

The sound pressure level of the pumps is lower than 70 dB(A).

11.3 Ambient temperature

Maximum ambient temperature	Liquid temperature
+55 °C (131 °F)	+90 °C (194 °F)
+50 °C (122 °F)	+100 °C (212 °F)*
+45 °C (113 °F)	+110 °C (230 °F)*
+40 °C (104 °F)	+120 °C (248 °F)*

* **Note:** Only the stainless-steel variant (EN 1.4301/AISI 304) is suitable for pumping liquids with temperatures above +90 °C (194 °F).

11.4 Maximum system pressure and permissible liquid temperature

Material variant	Shaft seal	Permissible liquid temperature*		Maximum system pressure	
Cast iron (EN-GJL-200)	AVBx	-20 °C to +40 °C +41 °C to +90 °C	(-4 °F to 104 °F) (105.8 °F to 194 °F)	10 bar 6 bar	(145 psi) (87 psi)
	AQQx	-20 °C to +90 °C	(-4 °F to 194 °F)	10 bar	(145 psi)
Stainless steel (EN 1.4301/AISI 304)	AVBx	-20 °C to +40 °C +41 °C to +90 °C	(-4 °F to 104 °F) (105.8 °F to 194 °F)	10 bar 6 bar	(145 psi) (87 psi)
	AQQx	-20 °C*** to +90 °C +91 °C to +120 °C**	(-4 °F to 194 °F) (195.8 °F to 248 °F)	16 bar 10 bar	(232 psi) (145 psi)
Stainless steel (EN 1.4401/AISI 316)	AVBx	-20 °C to +40 °C +41 °C to +90 °C	(-4 °F to 104 °F) (105.8 °F to 194 °F)	10 bar 6 bar	(145 psi) (87 psi)
	AQQx	-20 °C*** to +90 °C +91 °C to +120 °C**	(-4 °F to 194 °F) (195.8 °F to 248 °F)	16 bar 10 bar	(232 psi) (145 psi)

* At liquid temperatures below 0 °C (32 °F), higher motor outputs may be needed due to increased viscosity, for instance if glycol has been added to the water.

** 120 °C applies only if the pump has an AQQE shaft seal.

*** CM pumps for pumping liquids at temperatures below -20 °C are available on request. Please contact Grundfos.

11.5 Minimum inlet pressure

The minimum inlet pressure "H" in metres head required during operation to avoid cavitation in the pump can be calculated from the following formula:

$$H = p_b \times 10.2 - \text{NPSH} - H_f - H_v - H_s$$

p_b = Barometric pressure in bar.
(Barometric pressure can be set to 1 bar.)
In closed systems, p_b indicates the system pressure in bar.

NPSH = Net Positive Suction Head in metres head (to be read from the NPSH curves on pages 306 to 308 at the highest flow the pump will be delivering).

H_f = Friction loss in suction pipe in metres head.

H_v = Vapour pressure in metres head, see fig. 16, page 309.
 t_m = liquid temperature.

H_s = Safety margin = min. 0.5 metres head.

If the calculated value of "H" is positive, the pump can operate with a maximum suction lift of "H" metres.

If the calculated value of "H" is negative, a minimum suction head of "H" metres is required during operation to avoid cavitation.

Example

$p_b = 1$ bar.

Pump type: CM 3, 50 Hz.

Flow rate: 4 m³/h.

NPSH (from fig. 12, page 306): 3.3 metres head.

$H_f = 3.0$ metres head.

Liquid temperature: 90 °C.

H_v (from fig. 16, page 309): 7.2 metres head.

$H = p_b \times 10.2 - \text{NPSH} - H_f - H_v - H_s$ [metres head].

$H = 1 \times 10.2 - 3.0 - 3.3 - 7.2 - 0.5 = -3.8$ metres head.

This means that a suction head of 3.8 metres is required during operation.

Pressure calculated in bar: $3.8 \times 0.0981 = 0.37$ bar.

Pressure calculated in kPa: $3.8 \times 9.81 = 37.3$ kPa.

11.6 Maximum inlet pressure

The actual inlet pressure plus the pressure when the pump is operating against a closed valve should always be lower than the maximum system pressure.

12. Fault finding



Warning

Before removing the terminal box cover, make sure that the power supply has been switched off.

The pumped liquid may be scalding hot and under high pressure. Before any removal or dismantling of the pump, the system must therefore be drained, or the isolating valves on either side of the pump must be closed.

Fault	Cause	Remedy
1. The pump does not run.	a) Supply failure.	Switch on the switch. Check cables and cable connections for defects and loose connections.
	b) Fuses are blown.	Check cables and cable connections for defects, and replace the fuses.
	c) Motor protection tripped.	See 2. a), b), c), d), e), f).
	d) Control-current circuit defective.	Repair or replace the control-current circuit.
2. Motor-protective circuit breaker has tripped (trips out immediately when supply is switched on).	a) Fuses are blown.	See 1. b).
	b) Contacts of the motor-protective circuit breaker or magnet coil defective.	Replace the contacts of the motor-protective circuit breaker, the magnet coil or the entire motor-protective circuit breaker.
	c) Cable connection is loose or faulty.	Check cables and cable connections for defects, and replace the fuses.
	d) Motor winding is defective.	Repair or replace the motor.
	e) The pump is mechanically blocked.	Switch off the power supply, and clean or repair the pump.
	f) The setting of the motor-protective circuit breaker is too low.	Set the motor-protective circuit breaker according to the rated current of the motor ($I_{1/1}$). See nameplate.
3. The motor-protective circuit breaker trips out occasionally.	a) The setting of the motor-protective circuit breaker is too low.	See 2. f).
	b) Periodic supply failure.	See 2. c).
	c) Periodically low voltage.	Check cables and cable connections for defects and loose connections. Check that the supply cable of the pump is correctly sized.
4. The motor-protective circuit breaker has not tripped out, but the pump is inadvertently out of operation.	a) See 1. a), b), d) and 2. e).	
5. The pump performance is unstable.	a) Pump inlet pressure too low.	Check the inlet conditions of the pump.
	b) Suction pipe is partly blocked by impurities.	Remove and clean the suction pipe.
	c) Leakage in suction pipe.	Remove and repair the suction pipe.
	d) Air in suction pipe or pump.	Vent the suction pipe/pump. Check the inlet conditions of the pump.

Fault	Cause	Remedy
6. The pump runs, but gives no water.	a) Pump inlet pressure too low.	See 5. a).
	b) The suction pipe is partly clogged by impurities.	See 5. b).
	c) The foot or non-return valve is stuck in its closed position.	Remove and clean, repair or replace the valve.
	d) Leakage in suction pipe.	See 5. c).
	e) Air in suction pipe or pump.	See 5. d).
7. The pump runs backwards when switched off.	a) Leakage in suction pipe.	See 5. c).
	b) Foot or non-return valve defective.	See 6. c).
	c) The foot valve is stuck in completely or partly open position.	See 6. c).
8. The pump runs with reduced performance.	a) Wrong direction of rotation.	Three-phase pumps only: Switch off the power supply with the external circuit breaker, and interchange two phases in the pump terminal box. See also section <i>8.2 Checking the direction of rotation.</i>
	b) See 5. a), b), c), d).	

13. Further product information

13.1 Service documentation

Service documentation is available on www.grundfos.com > International website > WebCAPS > Service.

If you have any questions, please contact the nearest Grundfos company or service workshop.

14. Disposal

This product or parts of it must be disposed of in an environmentally sound way:

1. Use the public or private waste collection service.
2. If this is not possible, contact the nearest Grundfos company or service workshop.

Subject to alterations.

Appendix

Type <input style="width: 150px;" type="text" value="1"/>		Tliq,max <input style="width: 50px;" type="text" value="7"/> °C <input style="width: 50px;" type="text" value="7"/> °F	
Model <input style="width: 150px;" type="text" value="2"/>		PMax <input style="width: 50px;" type="text" value="6"/> bar <input style="width: 50px;" type="text" value="6"/> PSI <input style="width: 50px;" type="text" value="6"/> MPa	
TAmb <input style="width: 50px;" type="text" value="3"/> °C <input style="width: 50px;" type="text" value="3"/> °F		MEI ≥ <input style="width: 50px;" type="text" value="5"/> ηp (%) <input style="width: 50px;" type="text" value="8"/> Insulation class <input style="width: 50px;" type="text" value="9"/> <input style="width: 50px;" type="text" value="10"/>	
50 ZH	Q nom <input style="width: 50px;" type="text" value="11"/> m ³ /h <input style="width: 50px;" type="text" value="11"/> GPM	60 HZ	Q nom <input style="width: 50px;" type="text" value="11"/> m ³ /h <input style="width: 50px;" type="text" value="11"/> GPM
	H nom <input style="width: 50px;" type="text" value="12"/> m <input style="width: 50px;" type="text" value="12"/> PSI		H nom <input style="width: 50px;" type="text" value="12"/> m <input style="width: 50px;" type="text" value="12"/> PSI
	H max <input style="width: 50px;" type="text" value="13"/> m <input style="width: 50px;" type="text" value="13"/> PSI		H max <input style="width: 50px;" type="text" value="13"/> m <input style="width: 50px;" type="text" value="13"/> PSI

TM05 6388 4712

Fig. 9 Nameplate for pump

Motor Type <input style="width: 100px;" type="text" value="1"/> <input style="width: 100px;" type="text" value="2"/>			
50 Hz <input style="width: 100px;" type="text" value="3"/> V		60 Hz <input style="width: 100px;" type="text" value="3"/> V	
I 1/1 <input style="width: 100px;" type="text" value="4"/> A		I 1/1 <input style="width: 100px;" type="text" value="4"/> A	
P2 <input style="width: 50px;" type="text" value="5"/> kW <input style="width: 50px;" type="text" value="6"/> HP		P2 <input style="width: 50px;" type="text" value="5"/> kW <input style="width: 50px;" type="text" value="6"/> HP	
Eff:IE2 <input style="width: 50px;" type="text" value="7"/> % Capacitor <input style="width: 50px;" type="text" value="8"/> uF/V		Eff:IE2 <input style="width: 50px;" type="text" value="7"/> % Capacitor <input style="width: 50px;" type="text" value="8"/> uF/V	
<input style="width: 50px;" type="text" value="9"/> <input style="width: 50px;" type="text" value="10"/>		<input style="width: 50px;" type="text" value="11"/> <input style="width: 50px;" type="text" value="12"/>	
<input style="width: 50px;" type="text" value="13"/>		<input style="width: 50px;" type="text" value="13"/>	
DK-8850 BJERRINGBRO DENMARK Made in Hungary			

TM05 3823 1712

Fig. 10 Nameplate for motor

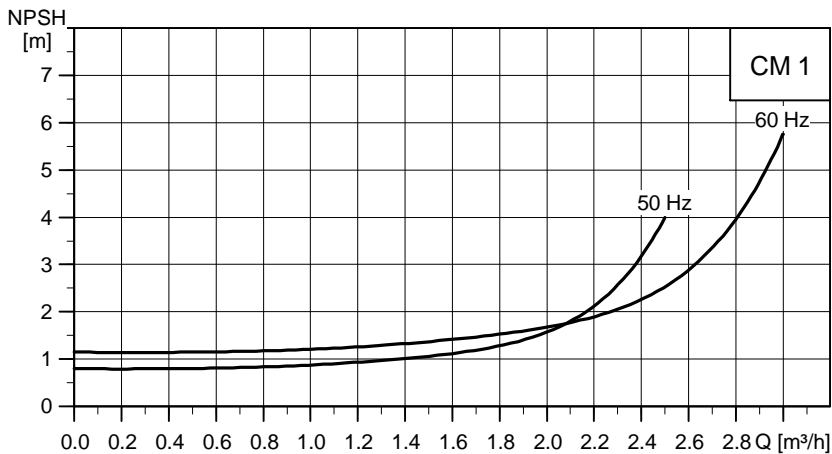

Fig. 11 NPSH curve for CM 1

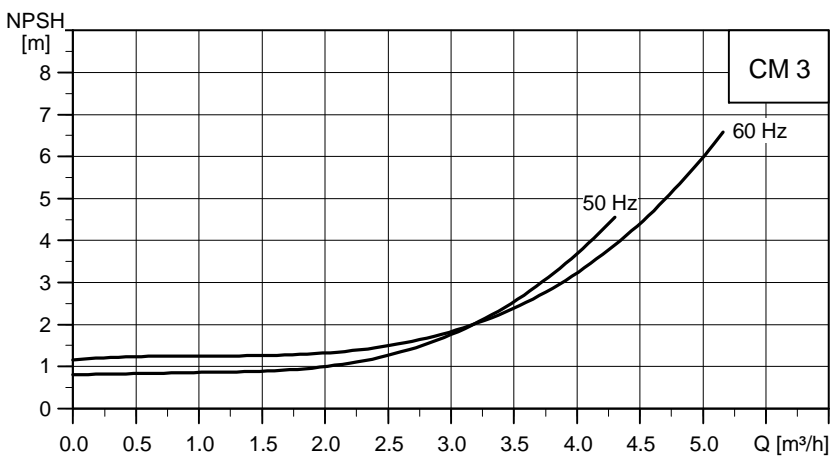
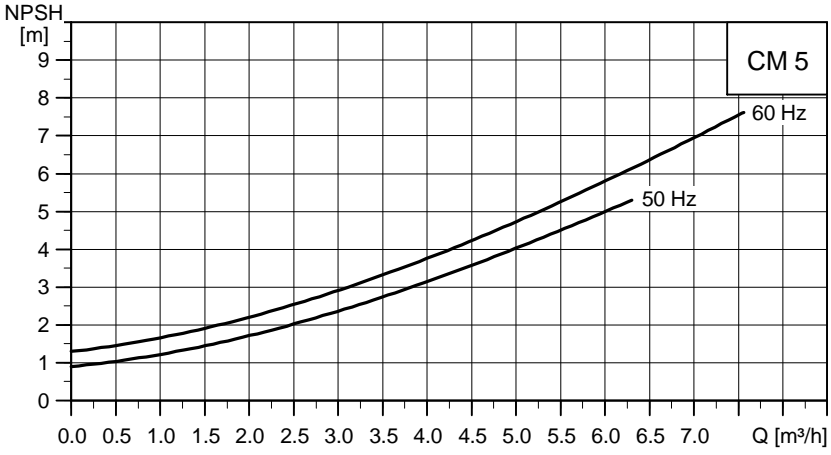

Fig. 12 NPSH curves for CM 3

TM04_0458_0309

TM04_0459_0309



TM04 0460 0309

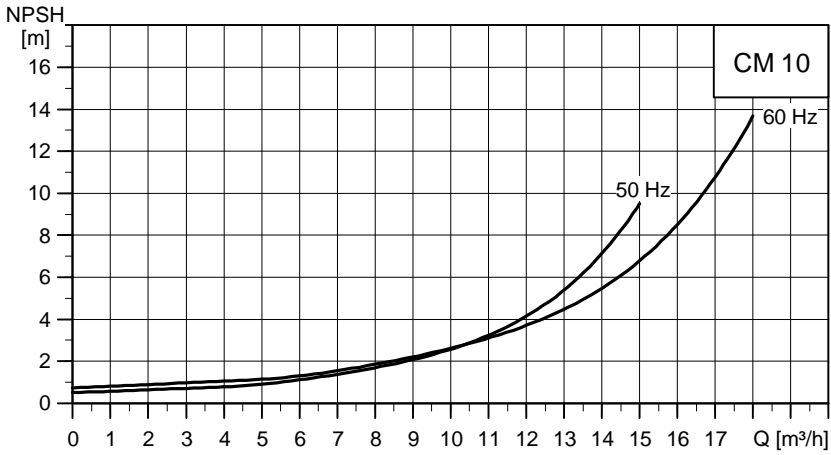

TM04 0461 0309

Fig. 13 NPSH curves for CM 10

TM04 0462 0309

TM04 0463 0309

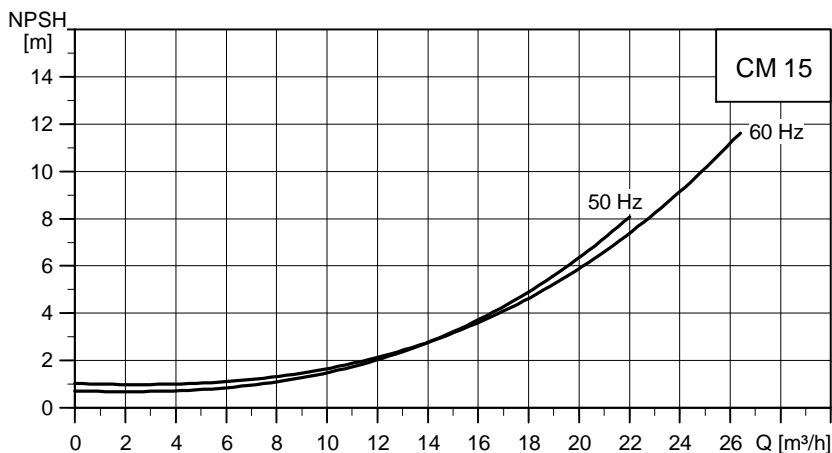

Fig. 14 NPSH curves for CM 15

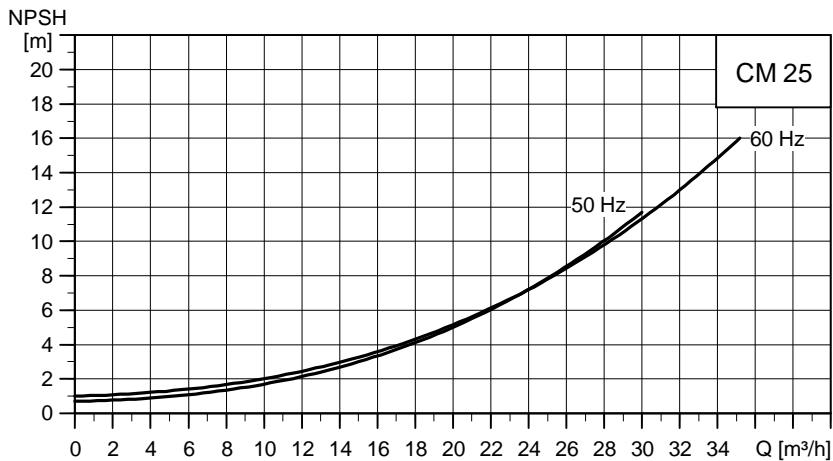

Fig. 15 NPSH curves for CM 25

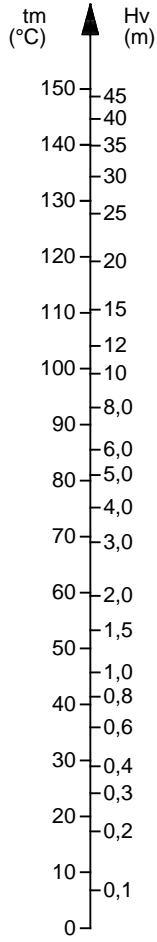

Fig. 16 Vapour pressure

TM00 3037 0800

Safety declaration

Please copy, fill in and sign this sheet and attach it to the pump returned for service.

Media and application

Which media has the pump been used for: _____

In which application has the pump been used: _____

Fault description

If possible please make a circle around the faulty part.
(In case of an electrical fault, please mark the terminal box.)

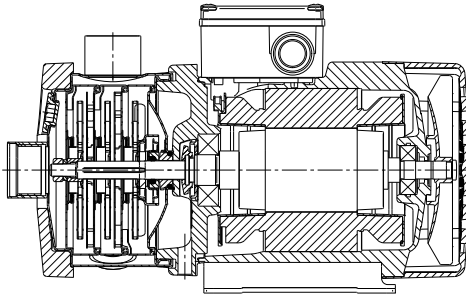

TM04 0359 1008

Please give a short description of the fault:

We hereby declare that this product is free from hazardous chemicals, biological and radioactive substances.

Date and signature

Company stamp

Argentina

Bombas GRUNDFOS de Argentina S.A.
Ruta Panamericana, ramal Campana
Centro Industrial Garin - Esq. Haendel y
Mozart
AR-1619 Garin Pcia. de Buenos Aires
Pcia. de Buenos Aires
Phone: +54-3327 414 444
Telefax: +54-3327 45 3190

Australia

GRUNDFOS Pumps Pty. Ltd.
P.O. Box 2040
Regency Park
South Australia 5942
Phone: +61-8-8461-4611
Telefax: +61-8-8340 0155

Austria

GRUNDFOS Pumpen Vertrieb
Ges. m.b.H.
Grundfosstraße 2
A-5082 Gröding/Salzburg
Tel.: +43-6246-883-0
Telefax: +43-6246-883-30

Belgium

N.V. GRUNDFOS Bellux S.A.
Boomsesteenweg 81-83
B-2630 Aartselaar
Tel.: +32-3-870 7300
Télécopie: +32-3-870 7301

Belarus

Представительство ГРУНДФОС в
Минске
220125, Минск
ул. Шафарнянская, 11, оф. 56
Тел.: +7 (375 17) 286 39 72, 286 39 73
Факс: +7 (375 17) 286 39 71
E-mail: minsk@grundfos.com

Bosnia/Herzegovina

GRUNDFOS Sarajevo
Trg Heroja 16,
BiH-71000 Sarajevo
Phone: +387 33 713 290
Telefax: +387 33 659 079
e-mail: grundfos@bih.net.ba

Brazil

BOMBAS GRUNDFOS DO BRASIL
Av. Humberto de Alencar Castelo
Branco, 630
CEP 09850 - 300
São Bernardo do Campo - SP
Phone: +55-11 4393 5533
Telefax: +55-11 4343 5015

Bulgaria

Grundfos Bulgaria EOOD
Slatina District
Iztochna Tangenta street no. 100
BG - 1592 Sofia
Tel. +359 2 49 22 200
Fax. +359 2 49 22 201
email: bulgaria@grundfos.bg

Canada

GRUNDFOS Canada Inc.
2941 Brighton Road
Oakville, Ontario
L6H 6C9
Phone: +1-905 829 9533
Telefax: +1-905 829 9512

China

GRUNDFOS Pumps (Shanghai) Co. Ltd.
50/F Maxdo Center No. 8 XingYi Rd.
Hongqiao development Zone
Shanghai 200336
PRC
Phone: +86 21 612 252 22
Telefax: +86 21 612 253 33

Croatia

GRUNDFOS CROATIA d.o.o.
Cebini 37, Buzin
HR-10010 Zagreb
Phone: +385 1 6595 400
Telefax: +385 1 6595 499
www.grundfos.hr

Czech Republic

GRUNDFOS s.r.o.
Čajkovského 21
779 00 Olomouc
Phone: +420-585-716 111
Telefax: +420-585-716 299

Denmark

GRUNDFOS DK A/S
Martin Bachs Vej 3
DK-8850 Bjerringbro
Tlf.: +45-87 50 50 50
Telefax: +45-87 50 51 51
E-mail: info_GDK@grundfos.com
www.grundfos.com/DK

Estonia

GRUNDFOS Pumps Eesti OÜ
Peterburi tee 92G
11415 Tallinn
Tel: + 372 606 1690
Fax: + 372 606 1691

Finland

OY GRUNDFOS Pumput AB
Mestarintie 11
FIN-01730 Vantaa
Phone: +358-3066 5650
Telefax: +358-3066 56550

France

Pompes GRUNDFOS Distribution S.A.
Parc d'Activités de Chesnes
57, rue de Malacombe
F-38290 St. Quentin Fallavier (Lyon)
Tel.: +33-4 74 82 15 15
Télécopie: +33-4 74 94 10 51

Germany

GRUNDFOS GMBH
Schlüterstr. 33
40699 Erkrath
Tel.: +49-(0) 211 929 69-0
Telefax: +49-(0) 211 929 69-3799
e-mail: infoservice@grundfos.de
Service in Deutschland:
e-mail: kundendienst@grundfos.de

HILGE GmbH & Co. KG
Hilgestrasse 37-47
55292 Bodenheim/Rhein
Germany
Tel.: +49 6135 75-0
Telefax: +49 6135 1737
e-mail: hilge@hilge.de

Greece

GRUNDFOS Hellas A.E.B.E.
20th km. Athinon-Markopoulou Av.
P.O. Box 71
GR-19002 Peania
Phone: +0030-210-66 83 400
Telefax: +0030-210-66 46 273

Hong Kong

GRUNDFOS Pumps (Hong Kong) Ltd.
Unit 1, Ground floor
Siu Wai Industrial Centre
29-33 Wing Hong Street &
68 King Lam Street, Cheung Sha Wan
Kowloon
Phone: +852-27861706 / 27861741
Telefax: +852-27858664

Hungary

GRUNDFOS Hungária Kft.
Park u. 8
H-2045 Törökbálint,
Phone: +36-23 511 110
Telefax: +36-23 511 111

India

GRUNDFOS Pumps India Private
Limited
118 Old Mahabalipuram Road
Thoraipakkam
Chennai 600 096
Phone: +91-44 2496 6800

Indonesia

PT GRUNDFOS Pompa
Jl. Rawasumur III, Blok III / CC-1
Kawasan Industri, Pulogadung
Jakarta 13930
Phone: +62-21-460 6909
Telefax: +62-21-460 6910 / 460 6901

Ireland

GRUNDFOS (Ireland) Ltd.
Unit A, Merrywell Business Park
Ballymount Road Lower
Dublin 12
Phone: +353-1-4089 800
Telefax: +353-1-4089 830

Italy

GRUNDFOS Pompe Italia S.r.l.
Via Gran Sasso 4
I-20060 Truccazzano (Milano)
Tel.: +39-02-95838112
Telefax: +39-02-95309290 / 95838461

Japan

GRUNDFOS Pumps K.K.
Gotanda Metalion Bldg., 5F,
5-21-15, Higashi-gotanda
Shiagawa-ku, Tokyo
141-0022 Japan
Phone: +81 35 448 1391
Telefax: +81 35 448 9619

Korea

GRUNDFOS Pumps Korea Ltd.
6th Floor, Aju Building 679-5
5-21-15, Higashi-gotanda
Shiagawa-ku, Tokyo
141-0022 Japan
Phone: +82-2-5317 600
Telefax: +82-2-5633 725

Latvia

SIA GRUNDFOS Pumps Latvia
Deglava biznesa centrs
Augusta Deglava iela 60, LV-1035, Rīga,
Tālr.: + 371 714 9640, 7 149 641
Fakss: + 371 914 9646

Lithuania

GRUNDFOS Pumps UAB
Smolensko g. 6
LT-03201 Vilnius
Tel: + 370 52 395 430
Fax: + 370 52 395 431

Malaysia

GRUNDFOS Pumps Sdn. Bhd.
7 Jalan Peguam U1/25
Glenmarie Industrial Park
40150 Shah Alam
Selangor
Phone: +60-3-5569 2922
Telefax: +60-3-5569 2866

Mexico

Bombas GRUNDFOS de México S.A. de C.V.
Boulevard TLC No. 15
Parque Industrial Stiva Aeropuerto
Apodaca, N.L. 66600
Phone: +52-81-8144 4000
Telefax: +52-81-8144 4010

Netherlands

GRUNDFOS Netherlands
Veluwezoom 35
1326 AE Almere
Postbus 22015
1302 CA ALMERE
Tel.: +31-88-478 6336
Telefax: +31-88-478 6332
E-mail: info_gnl@grundfos.com

New Zealand

GRUNDFOS Pumps NZ Ltd.
17 Beatrice Tinsley Crescent
North Harbour Industrial Estate
Albany, Auckland
Phone: +64-9-415 3240
Telefax: +64-9-415 3250

Norway

GRUNDFOS Pumper A/S
Strømsveien 344
Postboks 235, Leirdal
N-1011 Oslo
Tlf.: +47-22 90 47 00
Telefax: +47-22 32 21 50

Poland

GRUNDFOS Pompy Sp. z o.o.
ul. Klonowa 23
Baranowo k. Poznania
PL-62-081 Przeźmierowo
Tel: (+48-61) 650 13 00
Fax: (+48-61) 650 13 50

Portugal

Bombas GRUNDFOS Portugal, S.A.
Rua Calvet de Magalhães, 241
Apartado 1079
P-2770-153 Paço de Arcos
Tel.: +351-21-440 76 00
Telefax: +351-21-440 76 90

Romania

GRUNDFOS Pompe România SRL
Bd. Biruintei, nr 103
Pantelimon county Ilfov
Phone: +40 21 200 4100
Telefax: +40 21 200 4101
E-mail: romania@grundfos.ro

Russia

ООО Грундфос
Россия, 109544 Москва, ул. Школьная
39
Тел. (+7) 495 737 30 00, 564 88 00
Факс (+7) 495 737 75 36, 564 88 11
E-mail grundfos.moscow@grundfos.com

Serbia

GRUNDFOS Predstavništvo Beograd
Dr. Milutina Ivkovića 2a/29
YU-11000 Beograd
Phone: +381 11 26 47 877 / 11 26 47 496
Telefax: +381 11 26 48 340

Singapore

GRUNDFOS (Singapore) Pte. Ltd.
25 Jalan Tukang
Singapore 619264
Phone: +65-6681 9688
Telefax: +65-6681 9689

Slovenia

GRUNDFOS d.o.o.
Šlandrova 8b, SI-1231 Ljubljana-Črnuče
Phone: +386 1 568 0610
Telefax: +386 1 568 0619
E-mail: slovenia@grundfos.si

South Africa

GRUNDFOS (PTY) LTD
Corner Mountjoy and George Allen
Roads
Wilbart Ext. 2
Bedfordview 2008
Phone: (+27) 11 579 4800
Fax: (+27) 11 455 6066
E-mail: smart@grundfos.com

Spain

Bombas GRUNDFOS España S.A.
Camino de la Fuentecilla, s/n
E-28110 Algete (Madrid)
Tel.: +34-91-848 8800
Telefax: +34-91-628 0465

Sweden

GRUNDFOS AB
Box 333 (Lunnagårdsgatan 6)
431 24 Mölndal
Tel.: +46 31 332 23 000
Telefax: +46 31 331 94 60

Switzerland

GRUNDFOS Pumpen AG
Bruggacherstrasse 10
CH-8117 Fällanden/ZH
Tel.: +41-1-806 8111
Telefax: +41-1-806 8115

Taiwan

GRUNDFOS Pumps (Taiwan) Ltd.
7 Floor, 219 Min-Chuan Road
Taichung, Taiwan, R.O.C.
Phone: +886-4-2305 0868
Telefax: +886-4-2305 0878

Thailand

GRUNDFOS (Thailand) Ltd.
92 Chaloeam Phrakiat Rama 9 Road,
Dokmai, Pravej, Bangkok 10250
Phone: +66-2-725 8999
Telefax: +66-2-725 8998

Turkey

GRUNDFOS POMPA San. ve Tic. Ltd.
Sti.
Gebze Organize Sanayi Bölgesi
Ihsan dede Caddesi,
2. yol 200. Sokak No. 204
41490 Gebze/ Kocaeli
Phone: +90 - 262-679 7979
Telefax: +90 - 262-679 7905
E-mail: satis@grundfos.com

Ukraine

ТОВ ГРУНДФОС УКРАЇНА
01010 Київ, Вул. Московська 86,
Тел.: (+38 044) 390 40 50
Факс.: (+38 044) 390 40 59
E-mail: ukraine@grundfos.com

United Arab Emirates

GRUNDFOS Gulf Distribution
P.O. Box 16768
Jebel Ali Free Zone
Dubai
Phone: +971 4 8815 166
Telefax: +971 4 8815 136

United Kingdom

GRUNDFOS Pumps Ltd.
Grovebury Road
Leighton Buzzard/Beds. LU7 4TL
Phone: +44-1525-850000
Telefax: +44-1525-850011

U.S.A.

GRUNDFOS Pumps Corporation
17100 West 118th Terrace
Olathe, Kansas 66061
Phone: +1-913-227-3400
Telefax: +1-913-227-3500

Uzbekistan

Представительство ГРУНДФОС в
Ташкенте
700000 Ташкент ул.Усмана Носира 1-й
тулик 5
Телефон: (3712) 55-68-15
Факс: (3712) 53-36-35

Revised 10.12.2012

95121197 1212

ECM: 1104950

The name Grundfos, the Grundfos logo, and the payoff **be think innovate** are registered trademarks owned by Grundfos Holding A/S or Grundfos A/S, Denmark. All rights reserved worldwide.
