

Count	Description
1	<p data-bbox="225 338 427 367">MAGNA1 32-40 F</p> <div data-bbox="225 376 558 622">  </div> <p data-bbox="619 636 1070 663" style="text-align: center;">Product photo could vary from the actual product</p> <p data-bbox="225 667 491 696">Product No.: 99221263</p> <p data-bbox="225 698 1458 797">The new MAGNA1 is the simple option for a job well done. It is the perfect choice when replacing older circulators and due to its compliance with the EuP 2015 regulations, substantial savings on electricity is a reality. The ideal choice for basic performance needs in applications where basic system control and monitoring is desired.</p> <ul data-bbox="264 810 1347 1016" style="list-style-type: none"> • Monitoring via the fault relay, ensuring peace of mind • Digital start/stop input available for remote pump control • Continuous operation and reduced downtime with the wireless twin pump function (available on twin-head pumps) • High energy efficiency resulting in substantial savings on electricity • Easy setup and operation via the simple user interface • No maintenance due to the canned-rotor type design. <p data-bbox="225 1048 1034 1077">MAGNA1 is the simple and efficient choice for most applications including</p> <ul data-bbox="264 1079 727 1312" style="list-style-type: none"> • Heating <ul data-bbox="300 1108 528 1193" style="list-style-type: none"> - Main pump - Mixing loops - Heating surfaces • Cooling <ul data-bbox="300 1227 727 1312" style="list-style-type: none"> - Air conditioning surfaces - Ground source heat pump systems - Smaller chiller applications <p data-bbox="225 1373 300 1402">Liquid:</p> <p data-bbox="225 1404 719 1520">Pumped liquid: Water Liquid temperature range: 14 .. 230 °F Selected liquid temperature: 140 °F Density: 61.35 lb/ft³</p> <p data-bbox="225 1554 341 1583">Technical:</p> <p data-bbox="225 1585 943 1644">TF class: 110 Approvals on nameplate: CE, VDE, EAC, CN ROHS, WEEE</p> <p data-bbox="225 1677 341 1706">Materials:</p> <p data-bbox="225 1709 778 1825">Pump housing: Cast iron EN-GJL-200 ASTM A48-200B Impeller: PES 30%GF</p> <p data-bbox="225 1856 352 1886">Installation:</p> <p data-bbox="225 1888 719 2058">Range of ambient temperature: 32 .. 104 °F Maximum operating pressure: 145.04 psi Flange standard: DIN Pipe connection: DN 32 Pressure stage: PN 6/10 Port-to-port length: 8 11/16 in</p>



Company name:

Created by:

Phone:

Date:

11/11/2020

Count	Description
	Electrical data:
	Power input - P1: 9 .. 73 W
	Main frequency: 50 / 60 Hz
	Rated voltage: 1 x 230 V
	Maximum current consumption: 0.09 .. 0.59 A
	Enclosure class (IEC 34-5): X4D
	Insulation class (IEC 85): F
	Others:
	Energy (EEI): 0.20
	Net weight: 16.5 lb
	Gross weight: 18.7 lb
	Shipping volume: 0.57 ft ³
	Finnish LVI No.: 4615313

99221263 MAGNA1 32-40 F

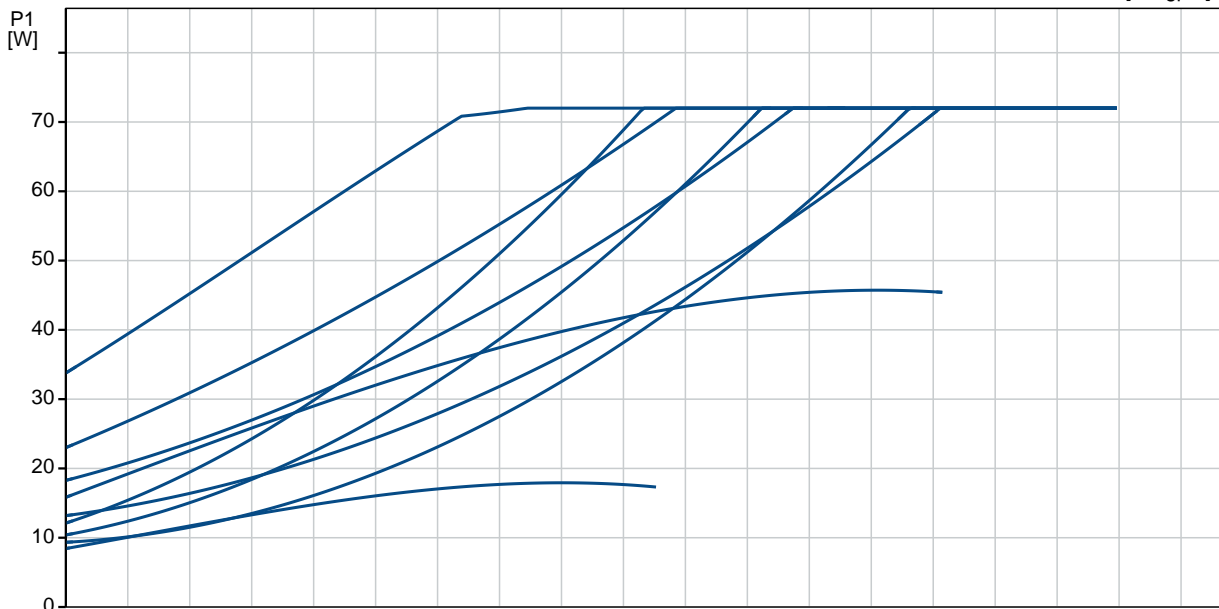
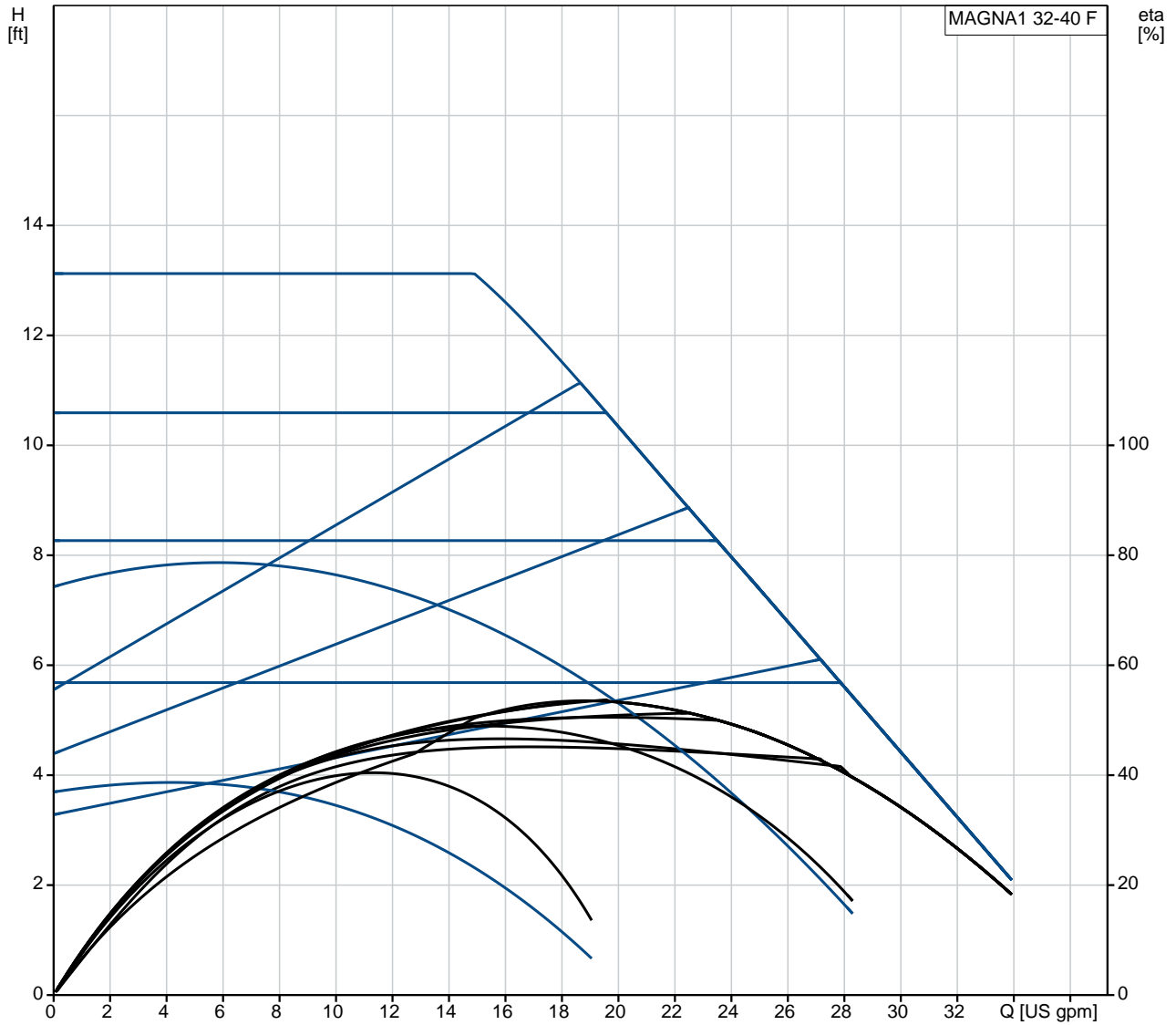

Description	Value
General information:	
Product name:	MAGNA1 32-40 F
Product No.:	99221263
EAN:	5712608942365
Technical:	
Head max:	13.12 ft
TF class:	110
Approvals on nameplate:	CE,VDE,EAC,CN ROHS,WEEE
Model:	C
Materials:	
Pump housing:	Cast iron
Pump housing:	EN-GJL-200
Pump housing:	ASTM A48-200B
Impeller:	PES 30%GF
Installation:	
Range of ambient temperature:	32 .. 104 °F
Maximum operating pressure:	145.04 psi
Flange standard:	DIN
Pipe connection:	DN 32
Pressure stage:	PN 6/10
Port-to-port length:	8 11/16 in
Liquid:	
Pumped liquid:	Water
Liquid temperature range:	14 .. 230 °F
Selected liquid temperature:	140 °F
Density:	61.35 lb/ft ³
Electrical data:	
Power input - P1:	9 .. 73 W
Main frequency:	50 / 60 Hz
Rated voltage:	1 x 230 V
Maximum current consumption:	0.09 .. 0.59 A
Enclosure class (IEC 34-5):	X4D
Insulation class (IEC 85):	F
Others:	
Energy (EEI):	0.20
Net weight:	16.5 lb
Gross weight:	18.7 lb
Shipping volume:	0.57 ft ³
Finnish LVI No.:	4615313

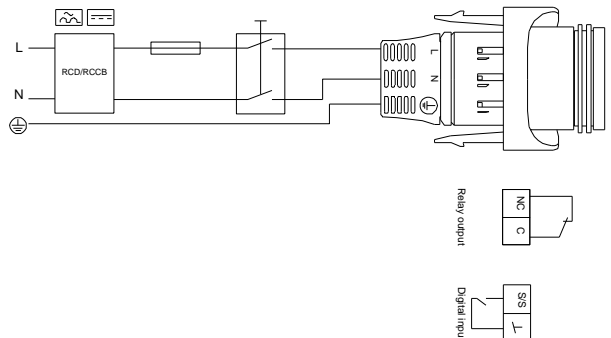
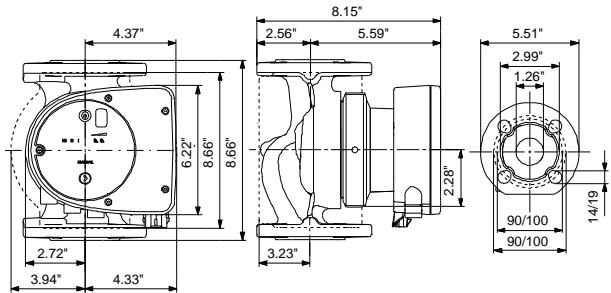
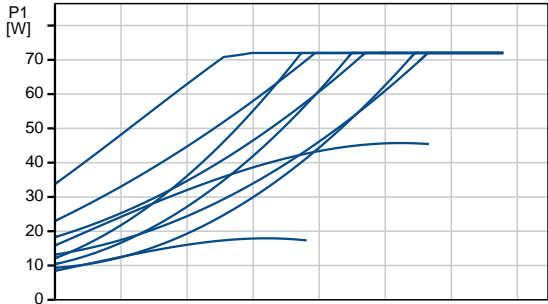
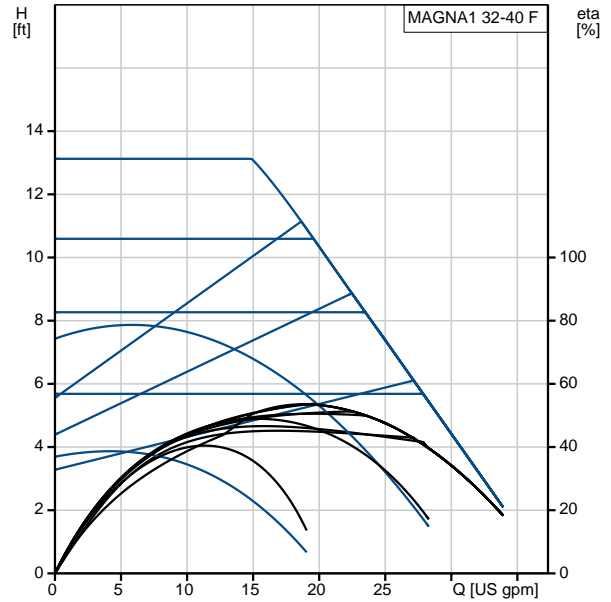

99221263 MAGNA1 32-40 F

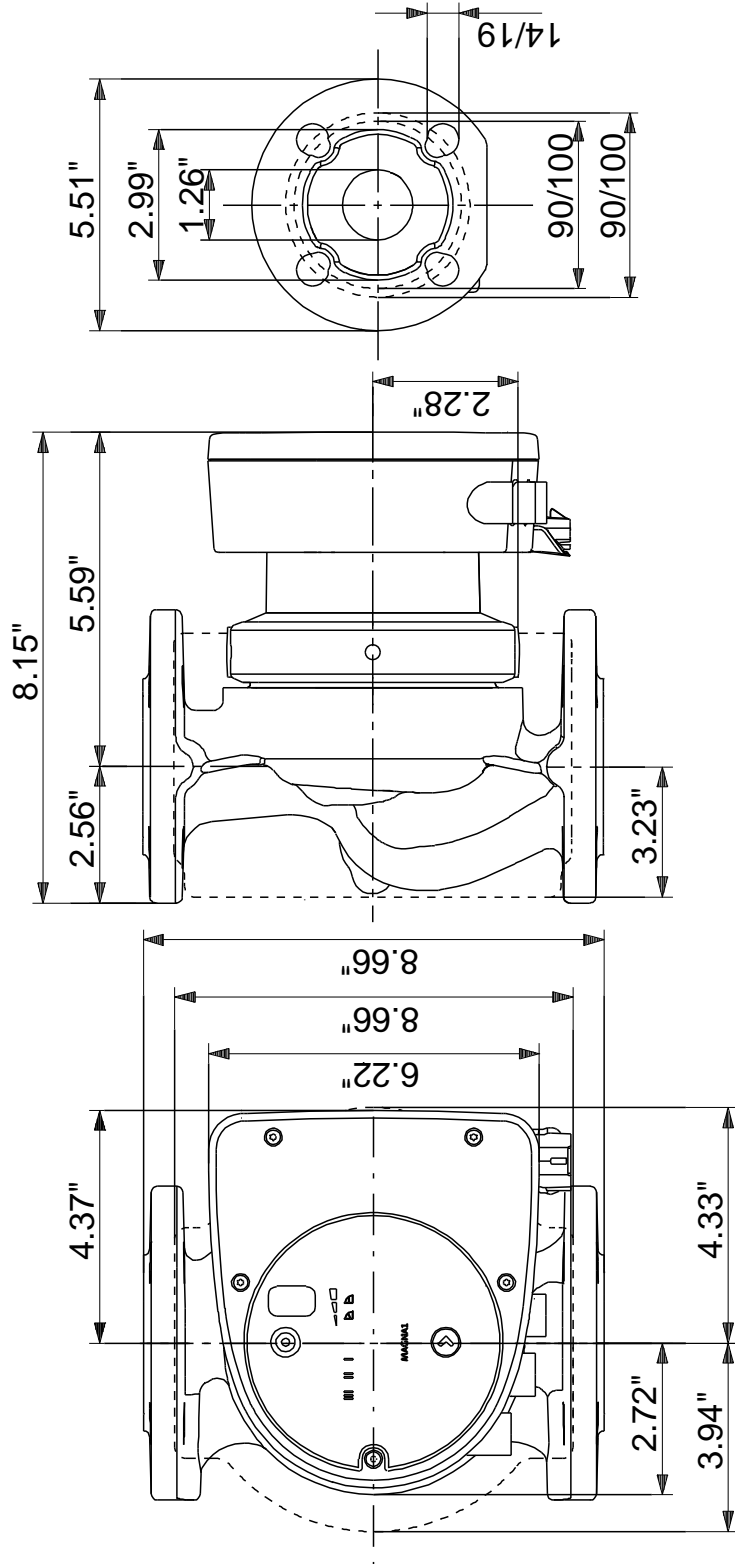

Note! All units are in [in] unless otherwise stated.
 Disclaimer: This simplified dimensional drawing does not show all details.

99221263 MAGNA1 32-40 F

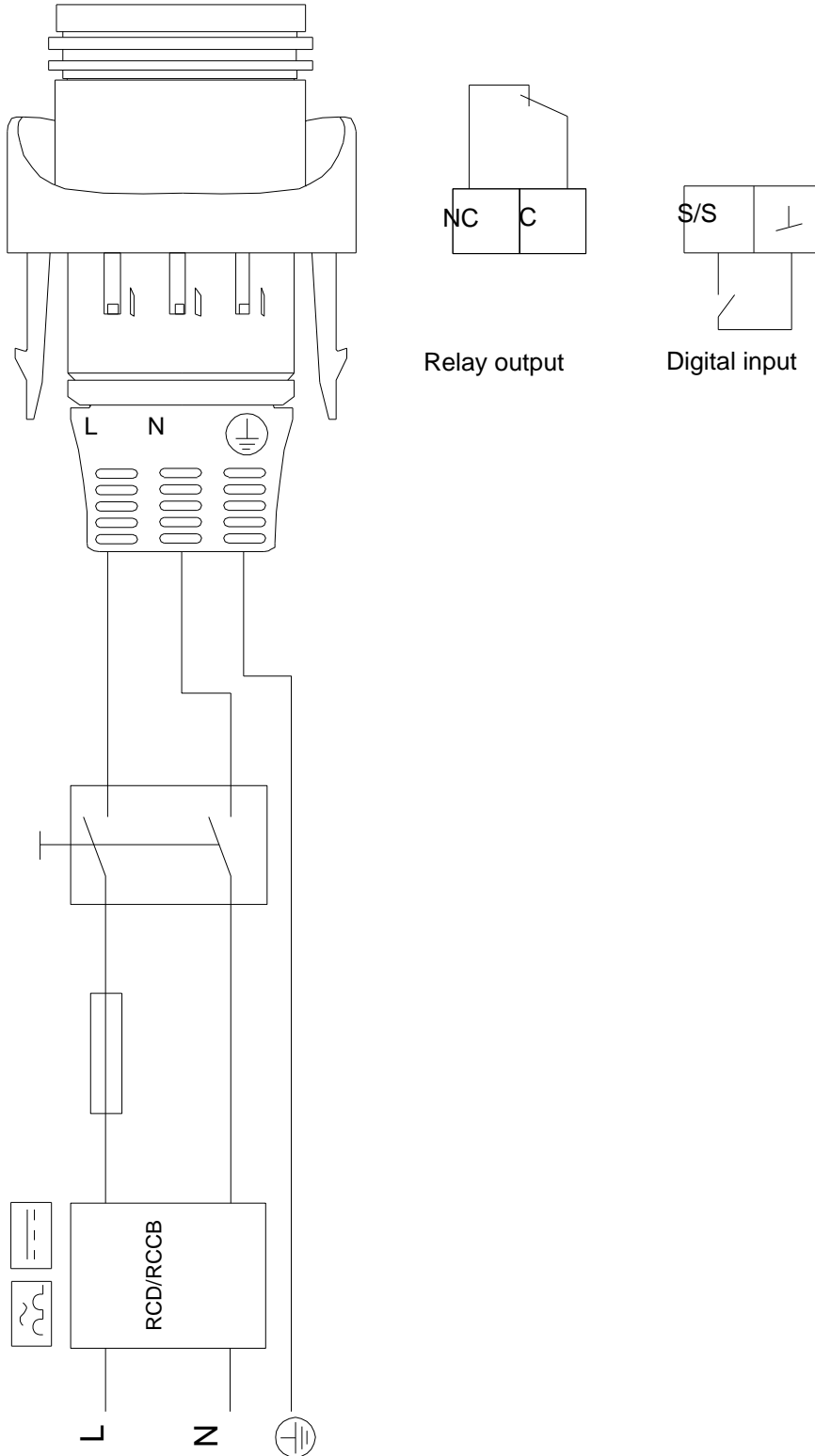

All units are [in] unless otherwise presented.