

**Qty. Description**

1 **MAGNA1 40-80 F N**



**Note! Product picture may differ from actual product**

Product No.: [99221323](#)

The new MAGNA1 is the simple option for a job well done. It is the perfect choice when replacing older circulators and due to its compliance with the EuP 2015 regulations, substantial savings on electricity is a reality. The ideal choice for basic performance needs in applications where basic system control and monitoring is desired.

- Monitoring via the fault relay, ensuring peace of mind
- Digital start/stop input available for remote pump control
- Continuous operation and reduced downtime with the wireless twin pump function (available on twin-head pumps)
- High energy efficiency resulting in substantial savings on electricity
- Easy setup and operation via the simple user interface
- No maintenance due to the canned-rotor type design.

MAGNA1 is the simple and efficient choice for most applications including

- Heating
  - Main pump
  - Mixing loops
  - Heating surfaces
- Cooling
  - Air conditioning surfaces
  - Ground source heat pump systems
  - Smaller chiller applications

**Liquid:**

Pumped liquid: Water  
 Liquid temperature range: -10 .. 110 °C  
 Selected liquid temperature: 60 °C  
 Density: 983.2 kg/m<sup>3</sup>

**Technical:**

TF class: 110  
 Approvals on nameplate: CE,VDE,EAC,CN ROHS,WEEE

**Materials:**

Pump housing: Stainless steel  
 EN 1.4308  
 ASTM 351 CF8  
 Impeller: PES 30%GF

**Installation:**

Range of ambient temperature: 0 .. 40 °C  
 Maximum operating pressure: 10 bar  
 Flange standard: DIN  
 Pipe connection: DN 40  
 Pressure rating: PN 6/10  
 Port-to-port length: 220 mm



**Company name:** Anchor Pumps Company Limited

**Created by:**

**Phone:**

**Date:** 17/11/2020

Qty.	Description																								
	<p>Electrical data:</p> <table><tr><td>Power input - P1:</td><td>17.03 .. 267 W</td></tr><tr><td>Mains frequency:</td><td>50 / 60 Hz</td></tr><tr><td>Rated voltage:</td><td>1 x 230 V</td></tr><tr><td>Maximum current consumption:</td><td>0.19 .. 1.18 A</td></tr><tr><td>Enclosure class (IEC 34-5):</td><td>X4D</td></tr><tr><td>Insulation class (IEC 85):</td><td>F</td></tr></table> <p>Others:</p> <table><tr><td>Energy (EEI):</td><td>0.20</td></tr><tr><td>Net weight:</td><td>17.1 kg</td></tr><tr><td>Gross weight:</td><td>18.7 kg</td></tr><tr><td>Shipping volume:</td><td>0.039 m<sup>3</sup></td></tr><tr><td>Country of origin:</td><td>DE</td></tr><tr><td>Custom tariff no.:</td><td>84137030</td></tr></table>	Power input - P1:	17.03 .. 267 W	Mains frequency:	50 / 60 Hz	Rated voltage:	1 x 230 V	Maximum current consumption:	0.19 .. 1.18 A	Enclosure class (IEC 34-5):	X4D	Insulation class (IEC 85):	F	Energy (EEI):	0.20	Net weight:	17.1 kg	Gross weight:	18.7 kg	Shipping volume:	0.039 m <sup>3</sup>	Country of origin:	DE	Custom tariff no.:	84137030
Power input - P1:	17.03 .. 267 W																								
Mains frequency:	50 / 60 Hz																								
Rated voltage:	1 x 230 V																								
Maximum current consumption:	0.19 .. 1.18 A																								
Enclosure class (IEC 34-5):	X4D																								
Insulation class (IEC 85):	F																								
Energy (EEI):	0.20																								
Net weight:	17.1 kg																								
Gross weight:	18.7 kg																								
Shipping volume:	0.039 m <sup>3</sup>																								
Country of origin:	DE																								
Custom tariff no.:	84137030																								

## 99221323 MAGNA1 40-80 F N

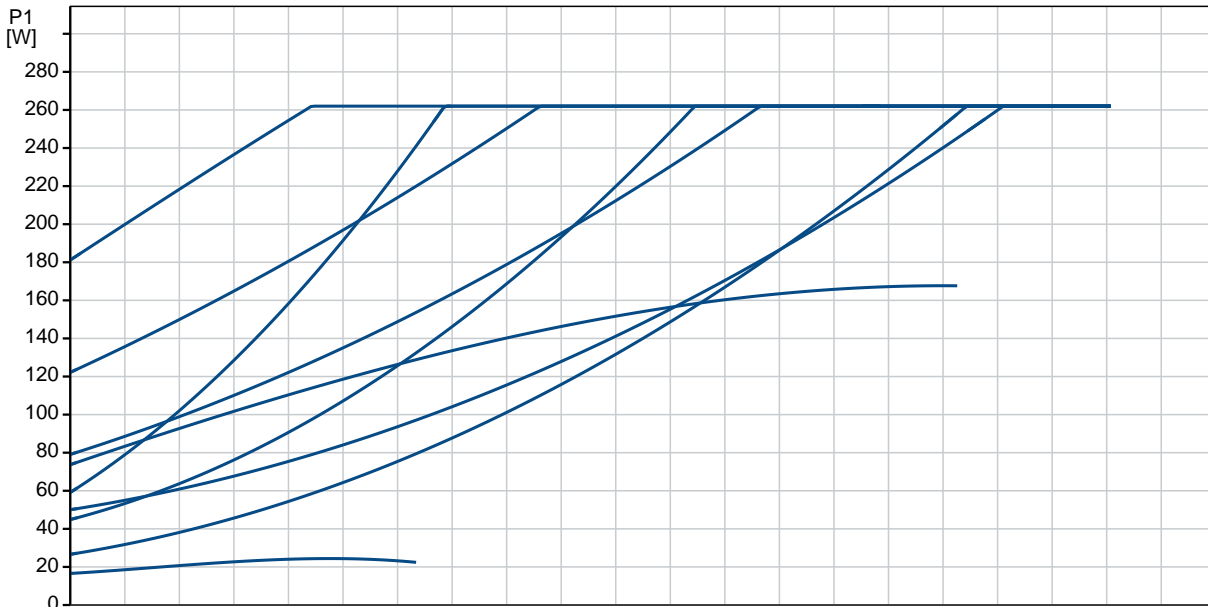
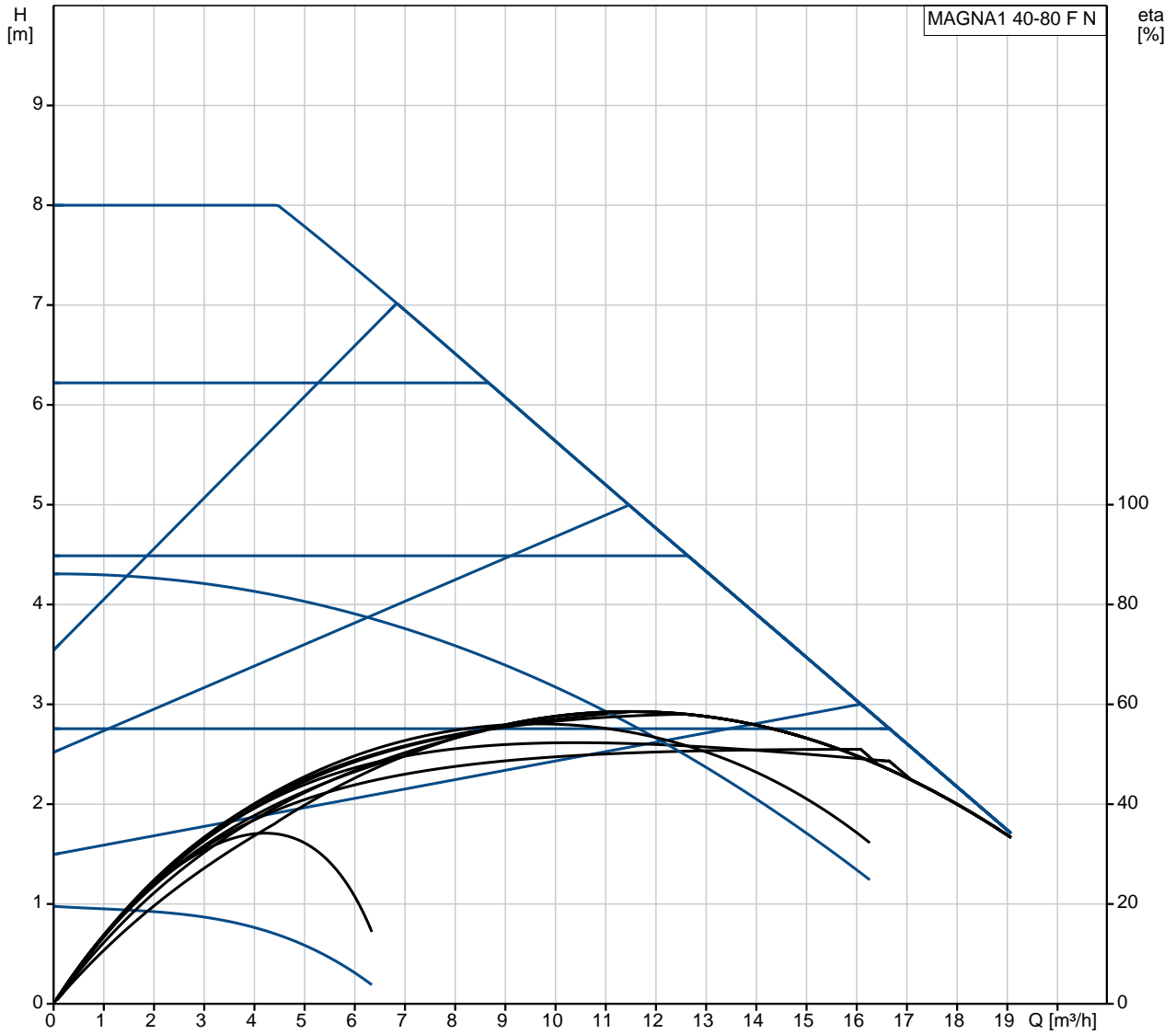

Description	Value
<b>General information:</b>	
Product name:	MAGNA1 40-80 F N
Product No:	99221323
EAN number:	5712608942969
<b>Technical:</b>	
Head max:	80 dm
TF class:	110
Approvals on nameplate:	CE,VDE,EAC,CN ROHS,WEEE
Model:	C
<b>Materials:</b>	
Pump housing:	Stainless steel
Pump housing:	EN 1.4308
Pump housing:	ASTM 351 CF8
Impeller:	PES 30%GF
<b>Installation:</b>	
Range of ambient temperature:	0 .. 40 °C
Maximum operating pressure:	10 bar
Flange standard:	DIN
Pipe connection:	DN 40
Pressure rating:	PN 6/10
Port-to-port length:	220 mm
<b>Liquid:</b>	
Pumped liquid:	Water
Liquid temperature range:	-10 .. 110 °C
Selected liquid temperature:	60 °C
Density:	983.2 kg/m <sup>3</sup>
<b>Electrical data:</b>	
Power input - P1:	17.03 .. 267 W
Mains frequency:	50 / 60 Hz
Rated voltage:	1 x 230 V
Maximum current consumption:	0.19 .. 1.18 A
Enclosure class (IEC 34-5):	X4D
Insulation class (IEC 85):	F
<b>Others:</b>	
Energy (EEL):	0.20
Net weight:	17.1 kg
Gross weight:	18.7 kg
Shipping volume:	0.039 m <sup>3</sup>
Country of origin:	DE
Custom tariff no.:	84137030

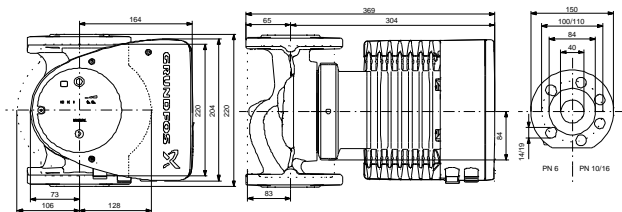
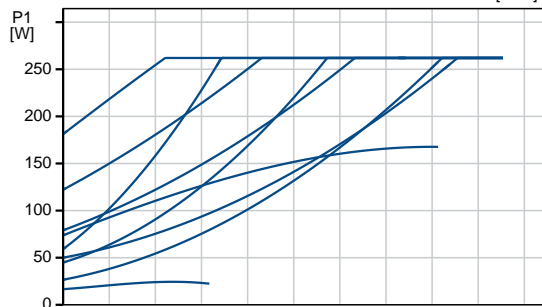
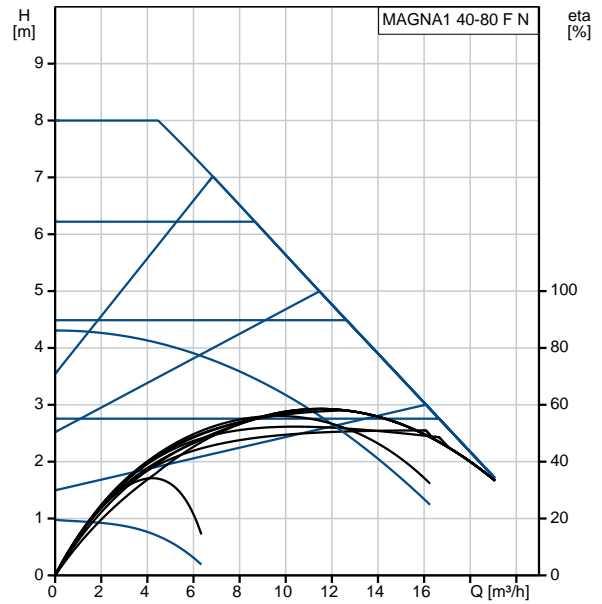

Example of mains-connected motor with mains switch, backup fuse and additional protection

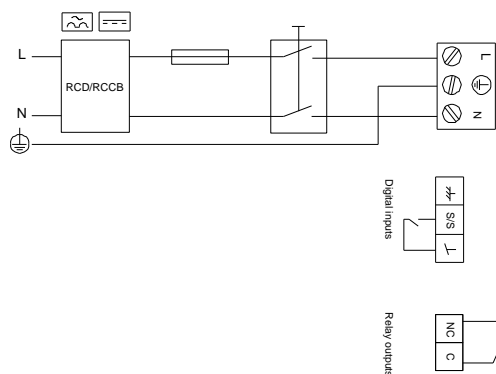

## 99221323 MAGNA1 40-80 F N

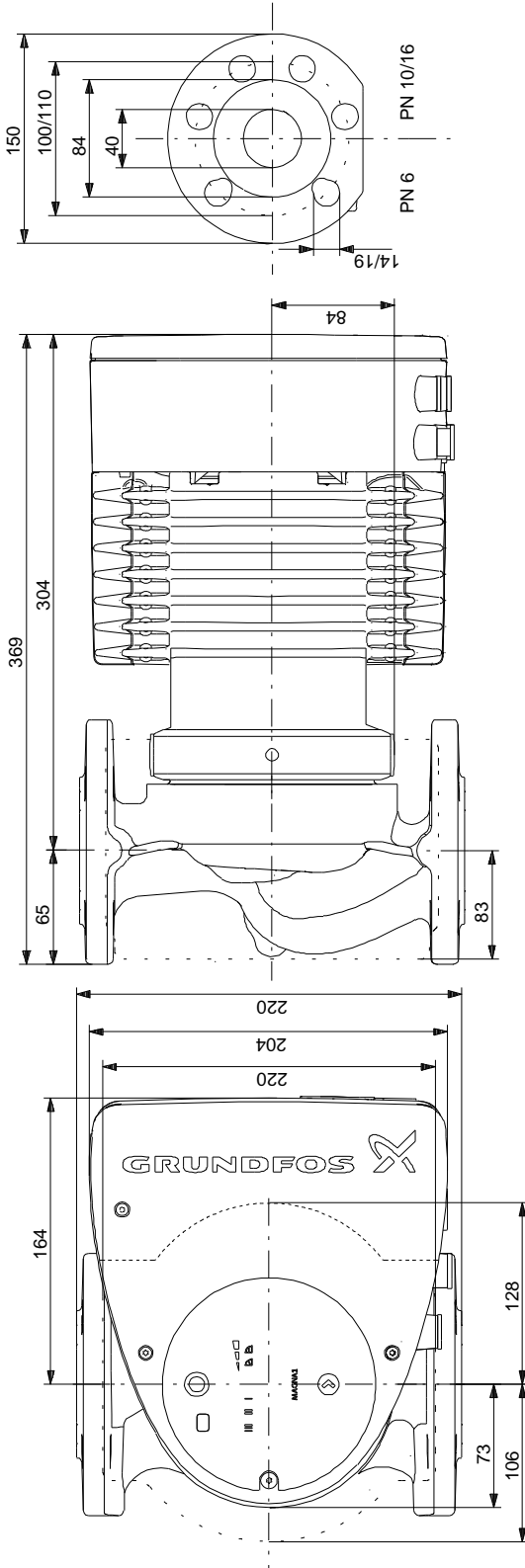

Note! All units are in [mm] unless others are stated.  
Disclaimer: This simplified dimensional drawing does not show all details.

## 99221323 MAGNA1 40-80 F N

Example of mains-connected motor with mains switch, backup fuse and additional protection

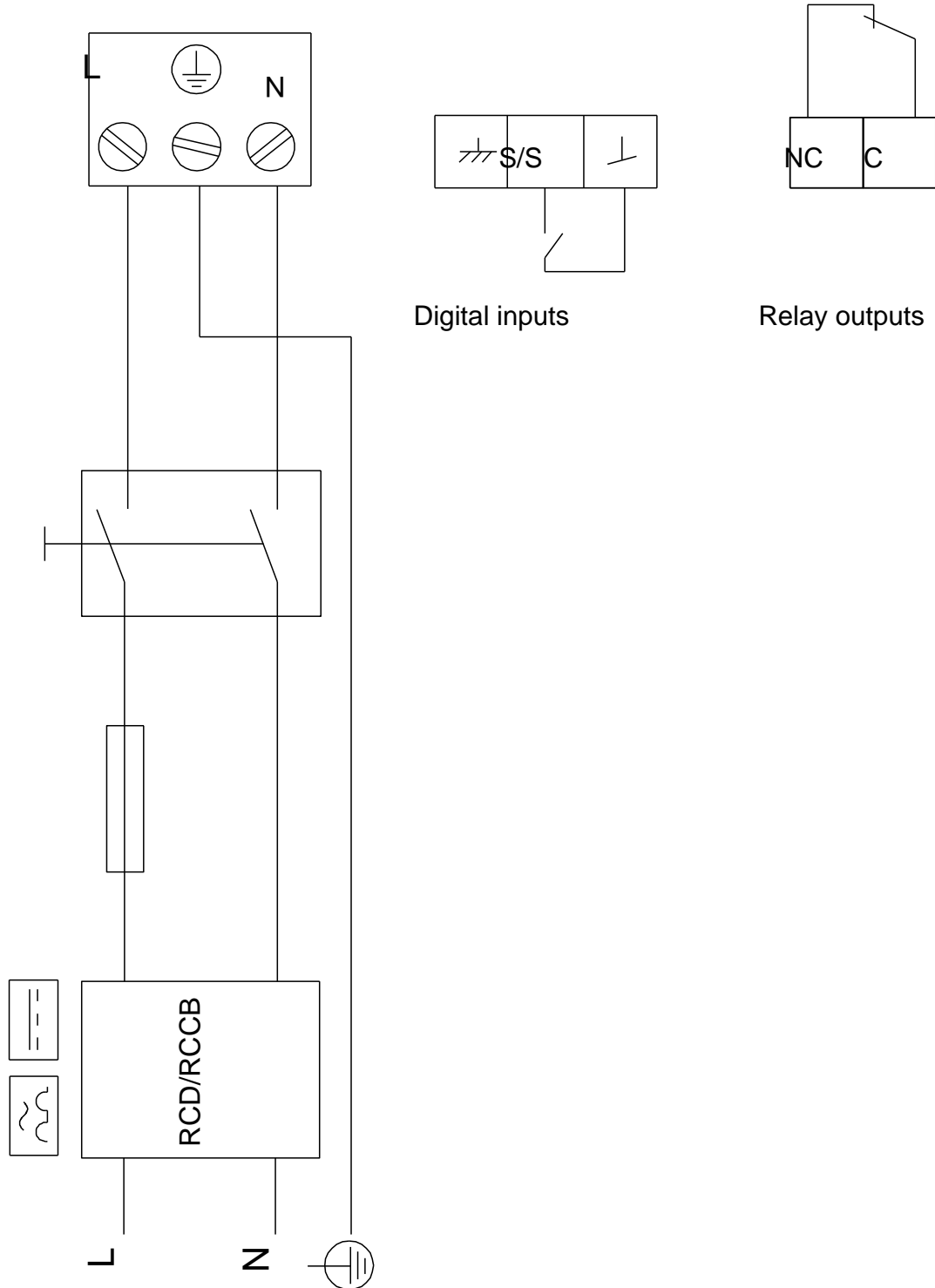

Note! All units are in [mm] unless others are stated.