

Qty.	Description
1	<p data-bbox="199 338 443 367">MAGNA3 D 50-100 F</p> <div data-bbox="279 510 497 667" style="text-align: center;">  </div> <p data-bbox="592 770 1075 795" style="text-align: center;">Note! Product picture may differ from actual product</p> <p data-bbox="199 801 469 828">Product No.: 97924478</p> <p data-bbox="199 862 1461 938">The Grundfos MAGNA3 circulator pump is the ideal choice for almost any building project – old or new. With its unrivalled energy efficiency, all-encompassing range and built-in communication capabilities, MAGNA3 is ideal for engineers and specifiers looking to create high-performance heating and cooling systems.</p> <p data-bbox="199 947 1461 1023">The pump is maintenance-free due to the canned-rotor type design. This also means that pump and motor form an integral unit without shaft seal and with only two gaskets for sealing. The bearings are lubricated by the pumped liquid.</p> <p data-bbox="199 1032 1417 1086">MAGNA3 features an intuitive display and allows you to connect wirelessly with the Grundfos GO Remote app, giving you access to advanced reporting and monitoring.</p> <p data-bbox="199 1095 1417 1149">The pump includes fieldbus communication via CIM modules as well analog and digital inputs and configurable relays.</p> <p data-bbox="199 1158 1461 1211">Control features include FLOWADAPT, which reduces the need for throttling valves, thus cutting costs on system components.</p> <p data-bbox="199 1220 1238 1247">MAGNA3 is the superior choice for a wide range of heating and cooling applications, including:</p> <ul data-bbox="199 1249 954 1384" style="list-style-type: none"> • Mixing loops Heating surfaces Air conditioning surfaces Ground-source heat pump systems Smaller chiller applications. <p data-bbox="199 1393 1437 1447">MAGNA3 is a single-phase pump and characterised by having the controller and control display integrated in the control box. The pump also has a built-in differential-pressure and temperature sensor.</p> <p data-bbox="199 1456 1437 1532">The pump housing is available in both cast-iron and stainless-steel versions. The composite rotor can be carbon-fibre reinforced, the bearing plate and rotor cladding are made of stainless steel and the stator housing is made of aluminium. The power electronics are air-cooled.</p> <p data-bbox="199 1541 1401 1617">MAGNA3 incorporates a 4-pole synchronous, permanent-magnet motor (PM motor). This motor type is characterised by higher efficiency than a conventional asynchronous squirrel-cage motor. The pump speed is controlled by an integrated frequency converter.</p> <p data-bbox="199 1626 309 1653">Features:</p> <ul data-bbox="199 1655 1449 2089" style="list-style-type: none"> • Vast communication options, including inputs, relays and fieldbus The most energy-efficient pump range within the industry Intelligent control functions Stainless-steel variant to accommodate domestic hot-water applications AutoAdapt FlowAdapt, which reduces the need for throttling valves, cutting costs on system components Proportional-pressure control Constant-pressure control Constant-temperature control Constant-flow control Differential-temperature control (requires an additional temperature sensor) Constant-curve duty Maximum and minimum curve duty Automatic night setback



Company name: Anchor Pumps Company Limited

Created by:

Phone:

Date: 20/11/2020

Qty.	Description
	<p>Heat energy monitor No external motor protection required Innovative clamp ring with only one screw enabling easy repositioning of the pump head Insulating shells supplied with single-head pumps for heating systems Large temperature range due to air-cooled electronics.</p>

97924478 MAGNA3 D 50-100 F

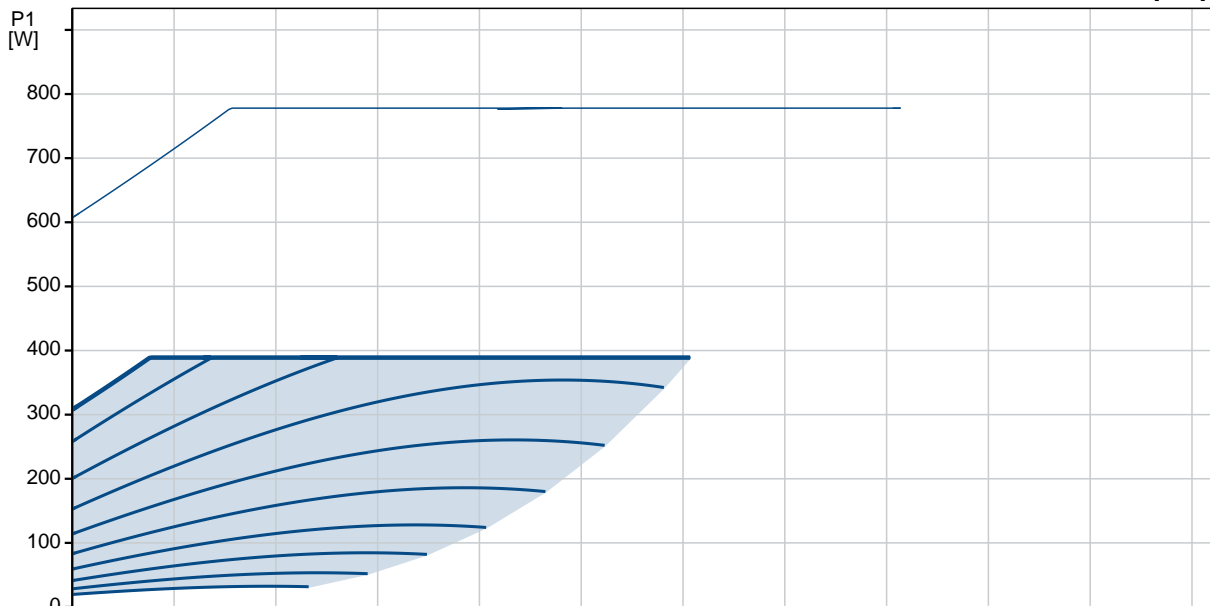
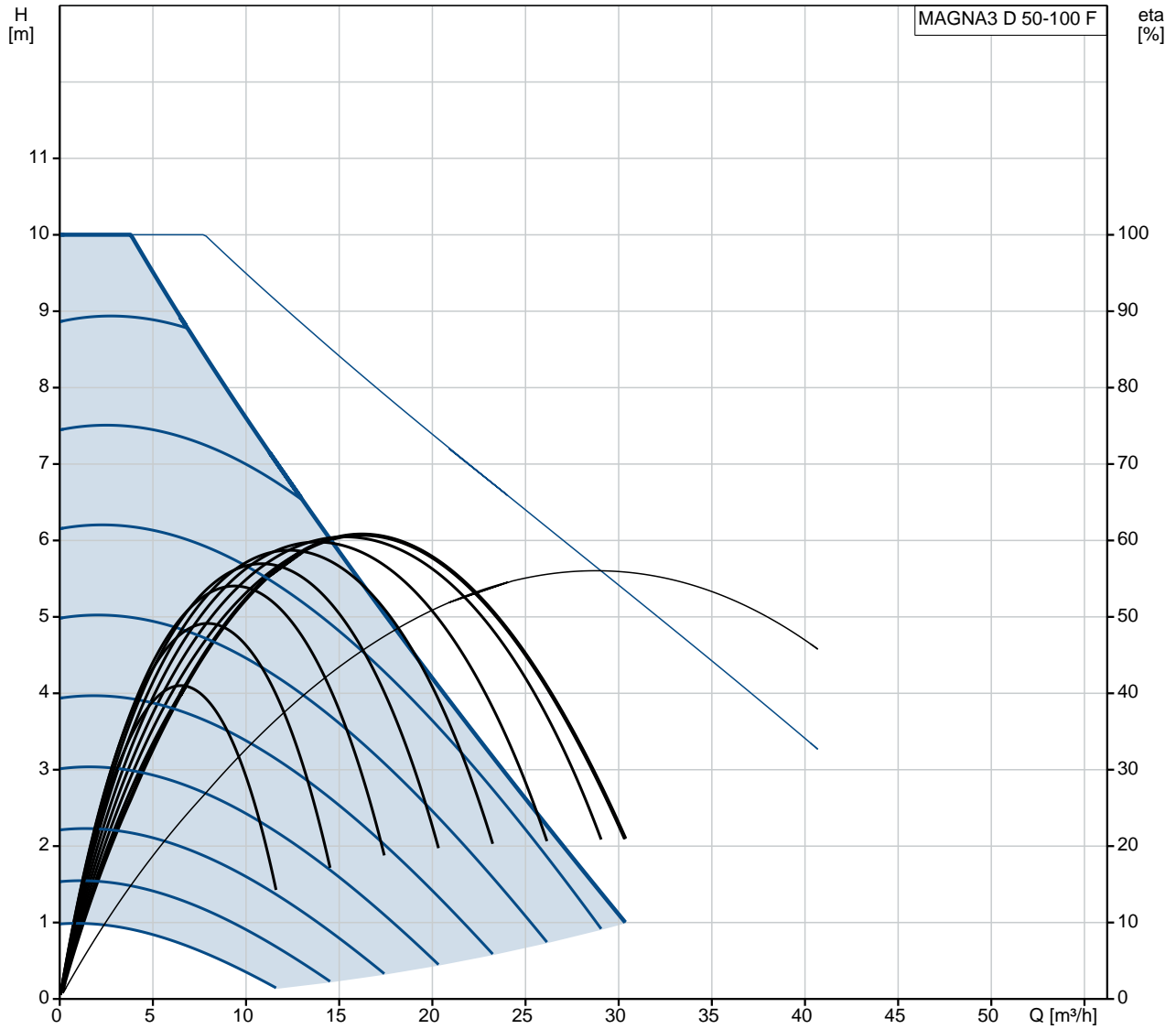

Description	Value
General information:	
Product name:	MAGNA3 D 50-100 F
Product No:	97924478
EAN number:	5710626495566
Technical:	
Rated flow:	15.59 m ³ /h
Rated head:	5.653 m
Head max:	100 dm
TF class:	110
Approvals on nameplate:	CE, VDE, EAC, CN ROHS, WEEE
Model:	D
Materials:	
Pump housing:	Cast iron
Pump housing:	EN-GJL-250
Pump housing:	ASTM A48-250B
Impeller:	PES 30%GF
Installation:	
Range of ambient temperature:	0 .. 40 °C
Maximum operating pressure:	10 bar
Flange standard:	DIN
Pipe connection:	DN 50
Pressure rating:	PN 6/10
Port-to-port length:	280 mm
Liquid:	
Pumped liquid:	Water
Liquid temperature range:	-10 .. 110 °C
Selected liquid temperature:	60 °C
Density:	983.2 kg/m ³
Electrical data:	
Power input - P1:	20 .. 389 W
Mains frequency:	50 / 60 Hz
Rated voltage:	1 x 230 V
Maximum current consumption:	0.21 .. 1.77 A
Enclosure class (IEC 34-5):	X4D
Insulation class (IEC 85):	F
Others:	
Energy (EEI):	0.19
Net weight:	34.1 kg
Gross weight:	41.7 kg
Shipping volume:	0.132 m ³
Swedish RSK No.:	5732538
Norwegian NRF no.:	9042771
Country of origin:	DE
Custom tariff no.:	84137030

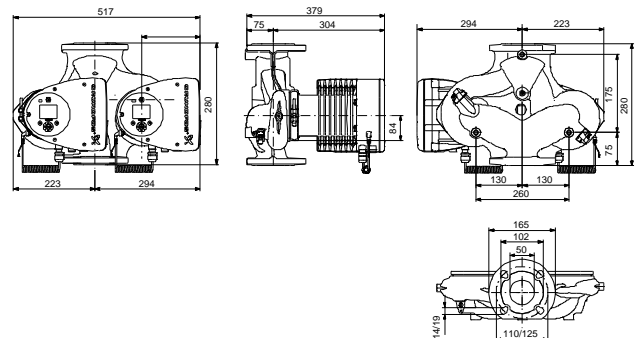
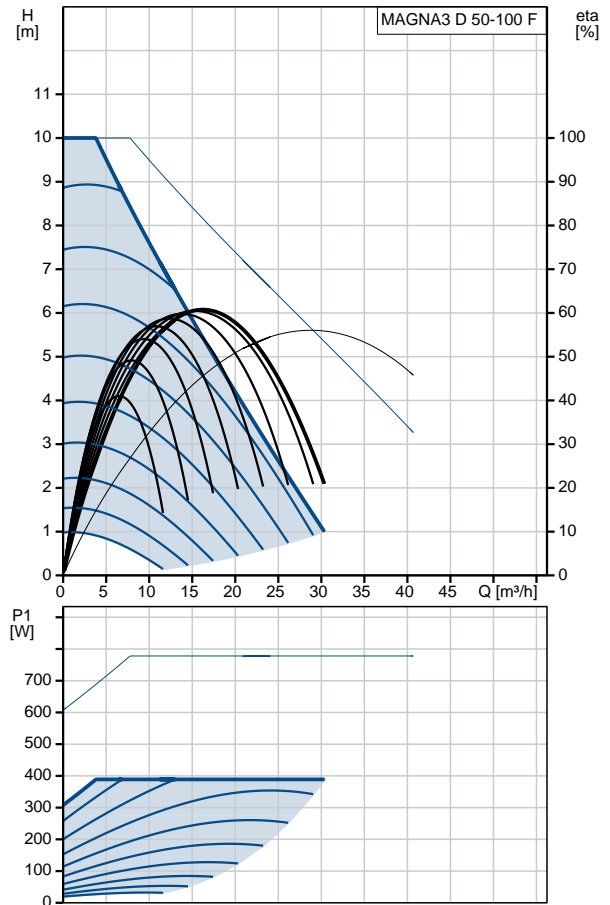

Example of mains-connected motor with mains switch, backup fuse and additional protection

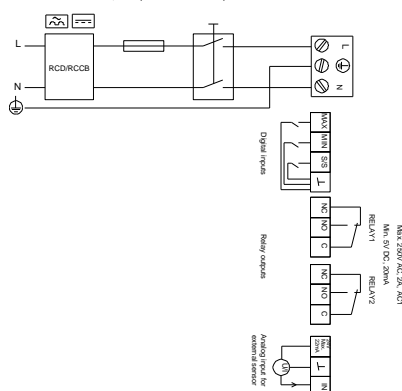

97924478 MAGNA3 D 50-100 F

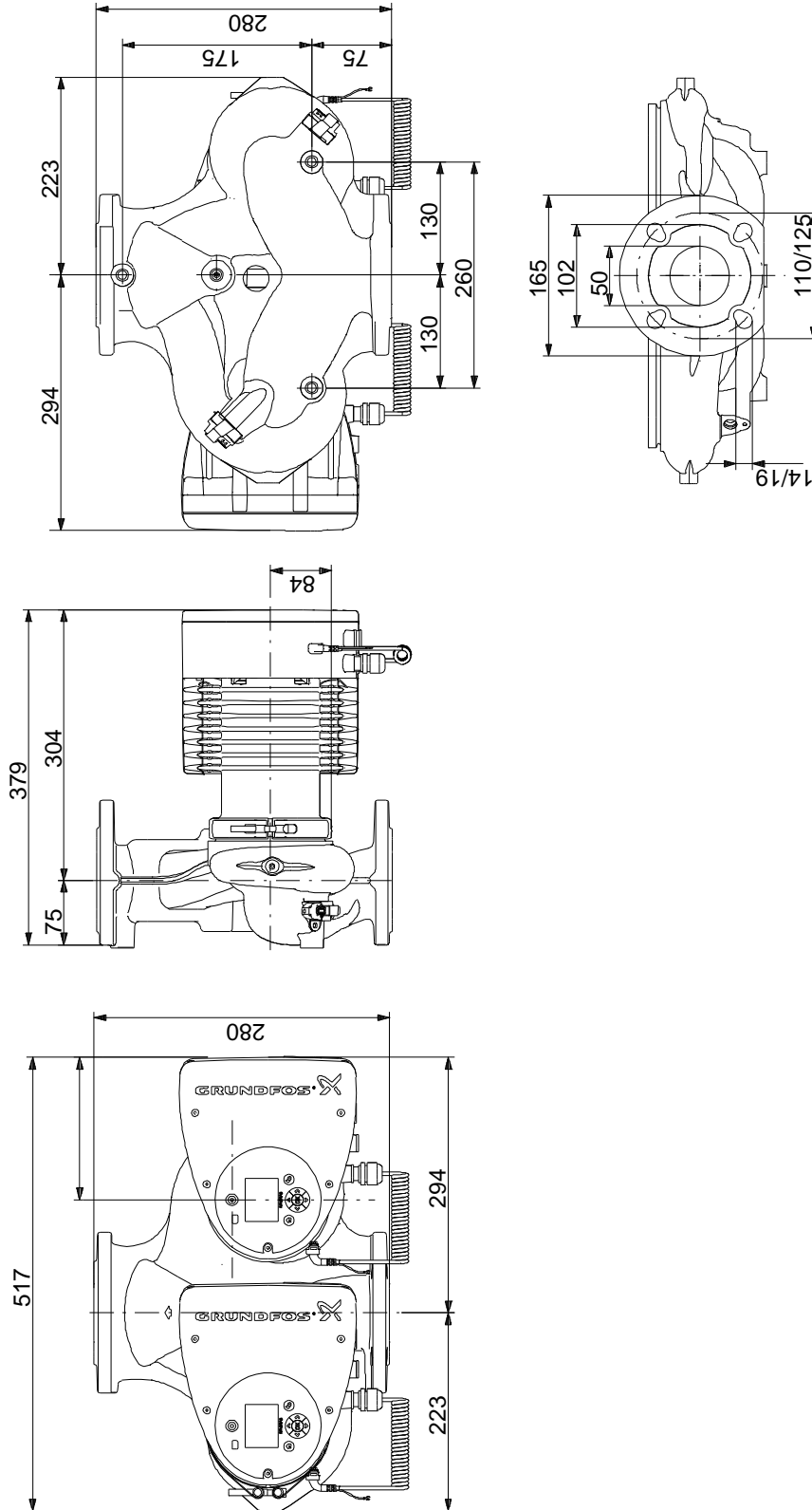

Note! All units are in [mm] unless others are stated.
Disclaimer: This simplified dimensional drawing does not show all details.

97924478 MAGNA3 D 50-100 F

Example of mains-connected motor with mains switch, backup fuse and additional protection



Note! All units are in [mm] unless others are stated.